

caleidos 



C'è un solo marchio riconosciuto in tutto il mondo come leader globale nel settore dei prodotti di lusso, tecnologicamente avanzati, per il bagno e la spa. Questo marchio è Jacuzzi®. Perché solo Jacuzzi® ha creato l'idromassaggio, geniale e avveniristica intuizione tutta italiana del 1956, e lo ha fatto diventare una consuetudine di benessere per milioni di persone. E solo Jacuzzi®, ancora oggi, è la vera ed originale esperienza di benessere che ogni anno si rinnova, con più di 300 brevetti, una gamma completa di prodotti ed un'unica mission: fare dell'eccellenza una sfida quotidiana per offrire la miglior esperienza di wellness.

There is only one brand recognised throughout the world as a global leader in the sector of luxury, technologically advanced products for the bath and spa. We are talking about the Jacuzzi® brand. Because no other than Jacuzzi® created the hydromassage, a brilliant and futuristic, all-Italian intuition that dates back to 1956, and made it become a wellness habit for millions of people. Even today, Jacuzzi® is the only real and original wellness experience that is renovated every year with more than 300 patents, a complete range of products and just one mission: to turn excellence into a daily challenge capable of offering the utmost in wellness.

# il benessere Jacuzzi: dall'esperienza nasce un nuovo stile di vita.

Wellness by Jacuzzi®: a new lifestyle is born from experience.

Con Jacuzzi®, il benessere prende forma. Quando una gamma di prodotti è ispirata al più alto senso di wellness, nasce una collezione di vere esperienze uniche: esperienze da vivere in prima persona, sulla propria pelle, in cui immergersi per ritrovare il piacere della cura di sé. Per Jacuzzi®, è questo il vero senso del benessere: scegliere di vivere i propri spazi, anche i più intimi, come ricerca ed espressione del proprio stile di vita. Quando il benessere prende forma, solo allora l'esperienza Jacuzzi® ha raggiunto la sua perfetta dimensione.

Wellness takes shape with Jacuzzi®. When a range of products is inspired by the highest sense of wellness, a collection of real and unique experiences is born: very personal experiences that are felt on one's skin, experiences in which one can immerse oneself to recover the pleasure of self care. For Jacuzzi®, this is the real meaning of wellness: the choice of experiencing one's spaces, even the most intimate ones, as a pursuit and an expression of one's lifestyle. The experience of Jacuzzi® reaches its perfect dimension only when wellness takes shape.



**Jacuzzi®** presenta **caleidos**: il sistema doccia per un'esperienza multisensoriale.

Jacuzzi® presents caleidos: the shower system for a multisensorial experience.

Con caleidos scoprirai un benessere totale e completo. Nuove sensazioni e nuove sperimentazioni ti guideranno attraverso un percorso fatto di relax ed emozione senza compromessi. Caleidos sarà il tuo prossimo viaggio.

Find out the real essence of an all-involving experience with caleidos. New sensations will guide you through a wellness path made of relax and emotions without compromise. Caleidos will be your next journey.









# Rigenera il tuo corpo

Regenerate your body





**Libera la mente**

Free your mind





## Jacuzzi® caleidos è cromodream®

Jacuzzi® caleidos is cromodream®

Il colore accenderà le tue emozioni e racconterà il tuo stato d'animo. Rilassati con il blu, cerca nuova energia con il rosso o trova un nuovo equilibrio ed un'irrinunciabile armonia con il verde. Vivi appieno un'esperienza davvero straordinaria capace di regalarti momenti di infinito piacere dove il concetto di positività si riverserà sul corpo e sullo spirito.



## Apri gli occhi, non è un sogno

Open your eyes, you are not dreaming

Colour will light up your emotions and narrate about your state of mind. Relax with blue, look for new energy with red or find harmony and natural balance with green. Live an extraordinary experience, able to instil endless pleasure moments that will affect you body and mind.



## **Jacuzzi**® caleidos è pioggia fresca o delicata nebulizzazione

Jacuzzi® caleidos can be either a fresh rain or a delicate water misting

Potrai raggiungere il tuo benessere attraverso modalità diverse ma sempre appaganti. Fatti cullare dal getto a pioggia o seleziona la nebulizzazione immergendoti in milioni di gocce che ti accarezzeranno.





## Scegli come farti coccolare

Choose how to be cocooned

Find your own wellness in various ways: different but always fulfilling. Pamper yourself with the rain shower or select water misting function and plunge into millions of caressing drops.



## Jacuzzi® caleidos è aromaterapia

Jacuzzi® caleidos is aromatherapy

L'aromaterapia trasformerà il tuo spazio più intimo in un vero paradiso dove profumi naturali, floreali ed energetici o rilassanti ti aiuteranno a raggiungere equilibrio, serenità e tranquillità. La doccia diventa pura emozione, magia capace di agire sulla nostra emotività e sul nostro profondo benessere.

Tre diverse profumazioni: DREAM, TONIC e BOUQUET asseconderanno le tue preferenze.

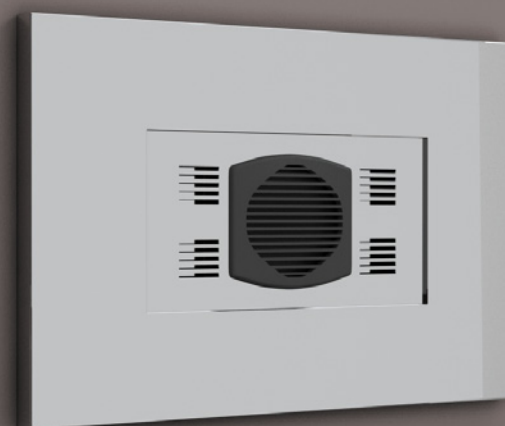

## Respira ed assapora una **nuova vitalità**

Breathe and taste a brand-new vitality

The aromatherapy will transform your most intimate space in a real paradise where natural, floral, energizing or relaxing essences will lead you to peace and tranquillity. The shower becomes pure emotion, a magic affecting our souls and wellbeing. Three different fragrances: dream, tonic and bouquet ready to fulfil your desires.



## Jacuzzi® caleidos getti e rubinetteria

Jacuzzi® caleidos jets and tapware

Caleidos significa personalizzazione del tuo spazio. Una completezza di gamma per un sistema doccia come tu desideri.



## In linea con il tuo stile

Consistent with your style

Caleidos means customization of your own space. A complete range for a shower system just like you desire.

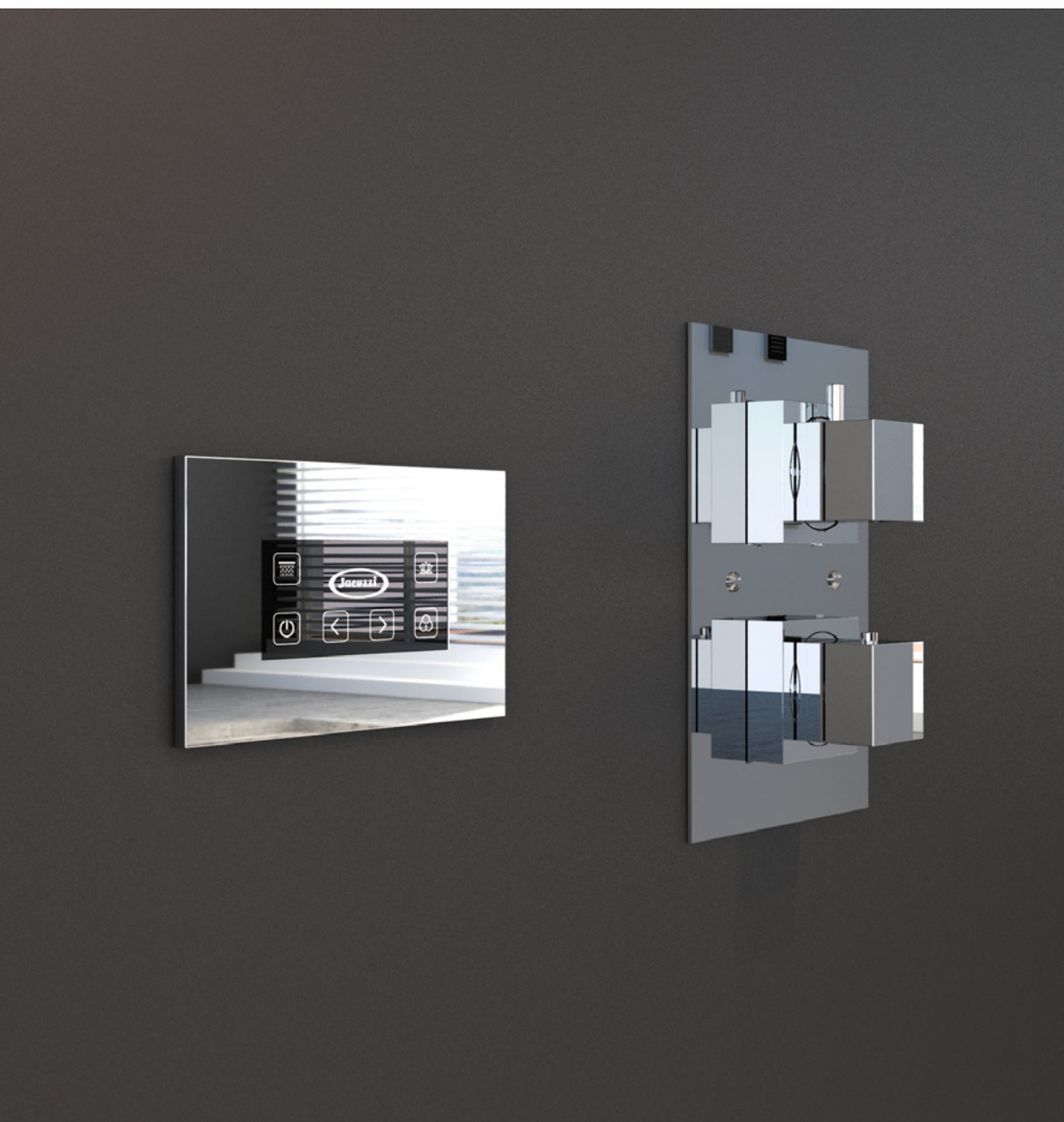



**Jacuzzi**® Tecnologia ed innovazione si traducono in benessere esclusivo.

Jacuzzi® Technology and innovation in a total wellness experience.



## Jacuzzi® caleidos 22

## Jacuzzi® caleidos 35

## Jacuzzi® caleidos 60

Versione	base	top
<b>TIPO INSTALLAZIONE</b> a soffitto, ad incasso fissaggio a parete o soffitto da abbinare a braccio di sospensione	•	•
<b>DOTAZIONI</b> Getto pioggia Getto pioggia centrale o cielo completo Nebulizzazione Cromodream® (led RGB) Tastiera di controllo touch screen Aromaterapia con diffusore	• • • •	• • • • • •
<b>CARATTERISTICHE TECNICHE</b> Alimentazione elettrica (Volt) a 50Hz Volt Pressione di esercizio bar Vie del deviatore impegnate	220-240 ca (12 Volt cc) min 1,5 - max 5 1	220-240 ca (12 Volt cc) min 1,5 - max 5 1

base	top
•	•
•	•
•	•
•	•
•	•
•	•
220-240 ca (12 Volt cc) min 1,5 - max 5 2	220-240 ca (12 Volt cc) min 1,5 - max 5 1

base	top	Version
•	•	<b>INSTALLATION</b> ceiling mounted, recessed for mounting an extension arm
•	•	<b>FEATURES</b> Raindrop shower head Complete and Central raindrop shower Water misting Cromodream® (led RGB) Touch screen electronic control Aromatherapy
•	•	<b>TECHNICAL SPECIFICATIONS</b> Volt Electric power (Volt) a 50Hz bar Operating pressure Diverter switch way used
220-240 ca (12 Volt cc) min 1,5 - max 5 2	220-240 ca (12 Volt cc) min 1,5 - max 5 1	

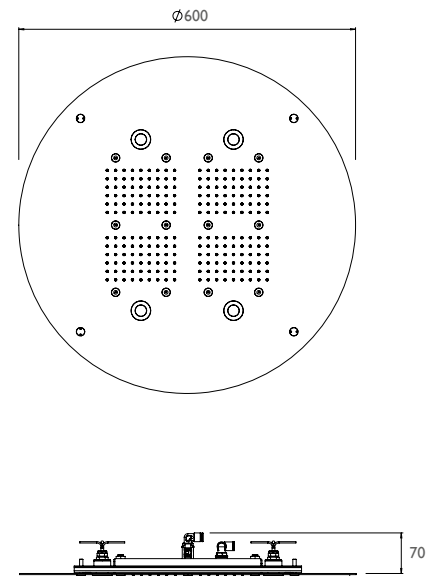
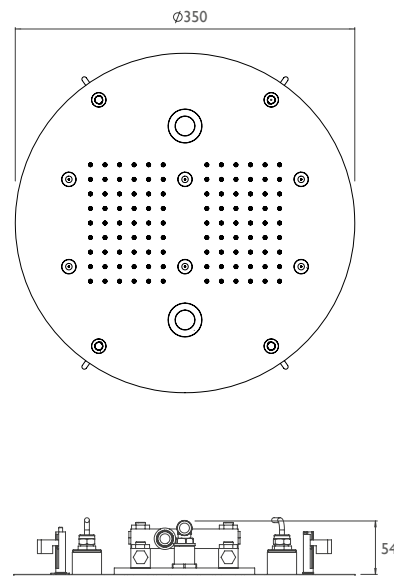
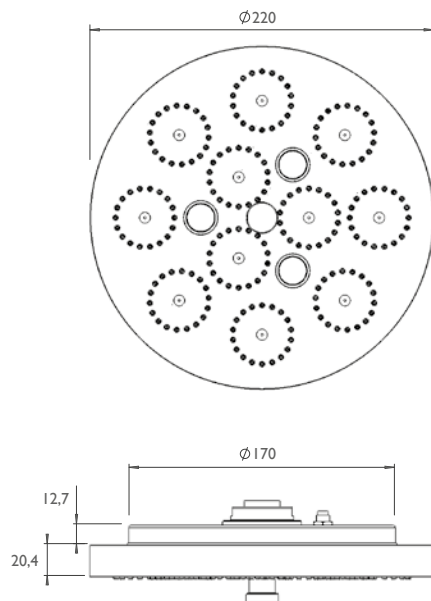



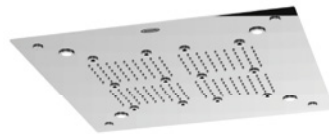
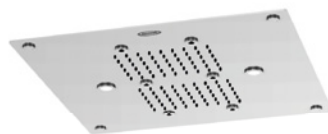

## Jacuzzi® caleidos 35x35

## Jacuzzi® caleidos 45x45

## Jacuzzi® caleidos 60x60

Versione	base	top
<b>TIPO INSTALLAZIONE</b>		
a soffitto, ad incasso	•	•
fissaggio a parete o soffitto da abbinare a braccio di sospensione		
<b>DOTAZIONI</b>		
Getto pioggia	•	•
Getto pioggia centrale o cielo completo		
Nebulizzazione	•	•
Cromodream® (led RGB)	•	•
Tastiera di controllo touch screen	•	•
Aromaterapia con diffusore		•
<b>CARATTERISTICHE TECNICHE</b>		
Alimentazione elettrica (Volt) a 50Hz	Volt 220-240 ca (12 Volt cc)	Volt 220-240 ca (12 Volt cc)
Pressione di esercizio	bar min 1,5 - max 5	bar min 1,5 - max 5
Vie del deviatore impegnate	2	1

base	top
•	•
•	•
•	•
•	•
•	•
•	•
220-240 ca (12 Volt cc)	220-240 ca (12 Volt cc)
min 1,5 - max 5	min 1,5 - max 5
2	1

base	top	Version
•	•	
•	•	
•	•	
•	•	
•	•	
•	•	
220-240 ca (12 Volt cc)	220-240 ca (12 Volt cc)	
min 1,5 - max 5	min 1,5 - max 5	
3	1	
		<b>INSTALLATION</b>
		ceiling mounted, recessed for mounting an extension arm
		<b>FEATURES</b>
		Raindrop shower head
		Complete and Central raindrop shower
		Water misting
		Cromodream® (led RGB)
		Touch screen electronic control
		Aromatherapy
		<b>TECHNICAL SPECIFICATIONS</b>
		Volt Electric power (Volt) a 50Hz
		bar Operating pressure
		Diverter switch way used

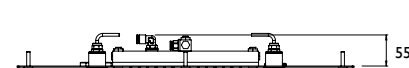
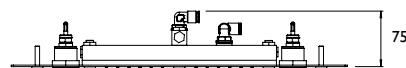
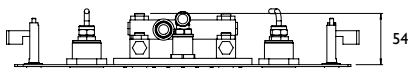
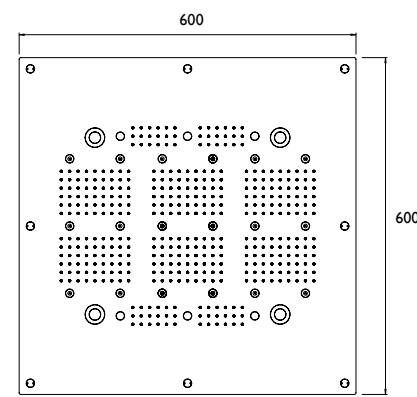
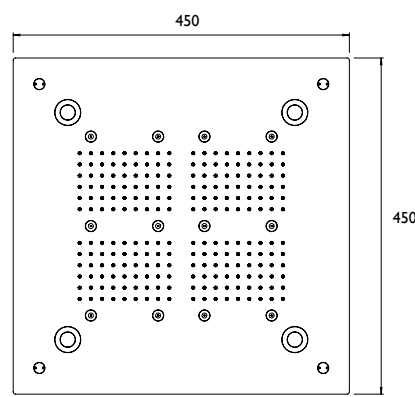
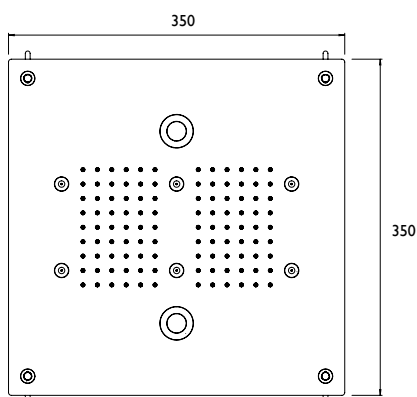

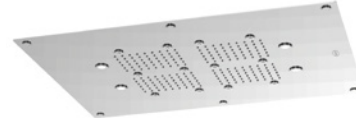

## Jacuzzi® caleidos 45x25

## Jacuzzi® caleidos 60x45

Versione	base	top
<b>TIPO INSTALLAZIONE</b> a soffitto, ad incasso fissaggio a parete o soffitto da abbinare a braccio di sospensione	•	•
<b>DOTAZIONI</b> Getto pioggia Getto pioggia centrale o cielo completo Nebulizzazione Cromodream® (led RGB) Tastiera di controllo touch screen Aromaterapia con diffusore	• • • • •	• • • • •
<b>CARATTERISTICHE TECNICHE</b> Alimentazione elettrica (Volt) a 50Hz Pressione di esercizio Vie del deviatore impegnate	Volt 220-240 ca (12 Volt cc) bar min 1,5 - max 5 2	Volt 220-240 ca (12 Volt cc) bar min 1,5 - max 5 1

Version	base	top
<b>INSTALLATION</b> ceiling mounted, recessed for mounting an extension arm	•	•
<b>FEATURES</b> Raindrop shower head Complete and Central raindrop shower Water misting Cromodream® (led RGB) Touch screen electronic control Aromatherapy	• • • • •	• • • • •
<b>TECHNICAL SPECIFICATIONS</b> Electric power (Volt) a 50Hz Operating pressure Diverter switch way used	Volt 220-240 ca (12 Volt cc) bar min 1,5 - max 5 2	Volt 220-240 ca (12 Volt cc) bar min 1,5 - max 5 1

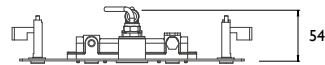
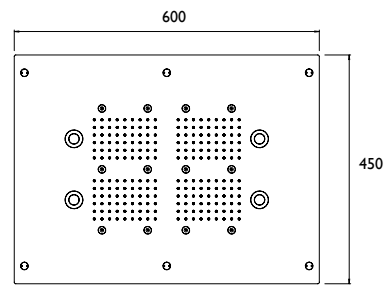
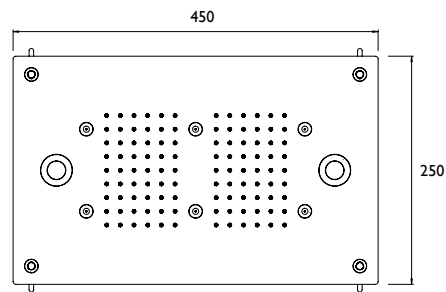

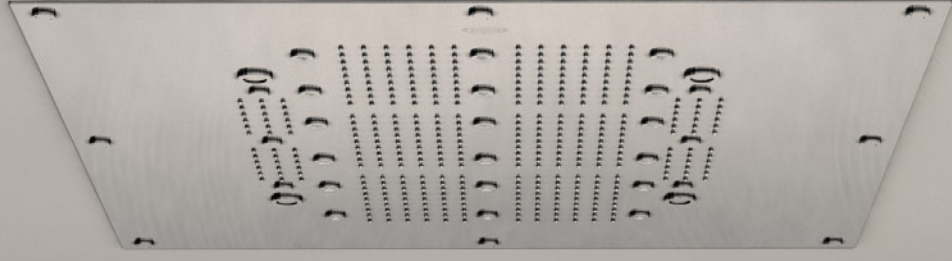





## Jacuzzi® caleidos, alcuni esempi di allestimenti

Jacuzzi® caleidos installation examples

modelli **base** / standard models



### Jacuzzi® caleidos modello **base** + deviatore 2 vie

Jacuzzi® caleidos base model + 2 way diverter switch

- deviatore a 2 vie per controllare le funzioni del soffione
- display touch screen a 4 tasti per la cromodream®
- 2 way diverter switch to control showerhead's functions
- 4 buttons touch screen display for cromodream®



### Jacuzzi® caleidos modello **base** + deviatore 3 vie

Jacuzzi® caleidos base model + 3 way diverter switch

- deviatore a 3 vie per controllare le funzioni del soffione o selezionare il doccino
- display touch screen a 4 tasti per la cromodream®
- 3 way diverter switch to control showerhead's functions or to select the handheld shower
- 4 buttons touch screen display for cromodream®

Il **display touch screen nei modelli top** consente il controllo di tutte le funzioni del solo soffione.

The touch screen display on top models gives you full control on showerhead's functions.

modelli **top** / top models



### **Jacuzzi® caleidos** modello **top** + deviatore 2 vie

Jacuzzi® caleidos top model + 2 way diverter switch

- deviatore a 2 vie per selezionare soffione o doccia
- display touch screen a 6 tasti per controllare le funzioni del soffione, la cromodream® e l'aromaterapia
- 2 way diverter switch to select the showerhead or the handheld shower
- 6 buttons touch screen display for cromodream®, aromatherapy and showerhead's functions



### **Jacuzzi® caleidos** modello **top** + deviatore 4 vie

Jacuzzi® caleidos top model + 4 way diverter switch

- deviatore a 4 vie per selezionare soffione, doccia o getti a parete
- display touch screen a 6 tasti per controllare le funzioni del soffione, la cromodream® e l'aromaterapia
- 4 way diverter switch to select the showerhead, the handheld shower or jets
- 6 buttons touch screen display for cromodream®, aromatherapy and showerhead's functions

# Jacuzzi® caleidos getti e rubinetteria

Jacuzzi® caleidos jets and tapware



Miscelatore ad incasso termostatico e deviatore a 5 vie con estetica rotonda. Disponibile anche a 2,3,4 vie.

Recessed mixer and 5 way diverter switch with rounded layout. Available with 2,3,4 ways.

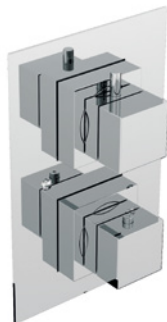

Miscelatore ad incasso termostatico e deviatore a 5 vie con estetica quadrata. Disponibile anche a 2,3,4 vie.

Recessed mixer and 5 way diverter switch with squared layout. Available with 2,3,4 ways.



Soffione laterale a parete Ø 7,5 cm.

Wall-mounted jet Ø 7,5 cm.

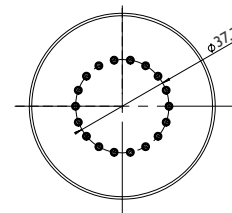
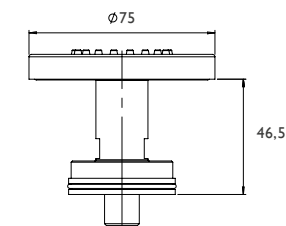

Soffione laterale a parete 7,5x7,5 cm.

Wall-mounted jet 7,5x7,5 cm.

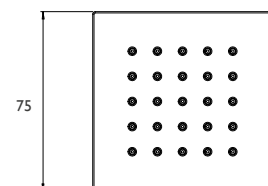
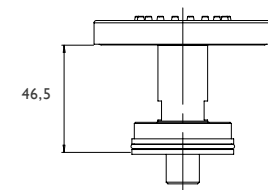





Braccio di sospensione orizzontale per soffione con predisposizione per cromodream®.

Horizontal shower head arm preset for cromodream®.

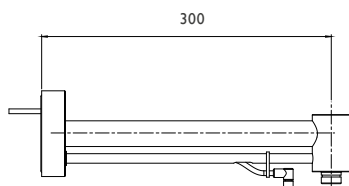

Braccio di sospensione verticale per soffione con predisposizione per cromodream®.

Vertical shower head arm preset for cromodream®.

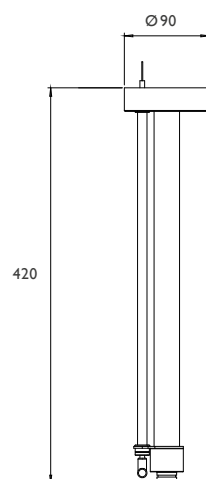

Sospensione a soffitto per soffione con predisposizione per cromodream®.

Shower head ceiling support preset for cromodream®.

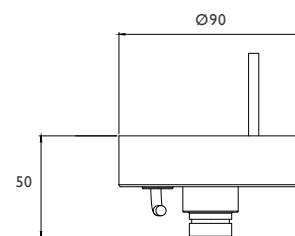

Abbinabili con doccini ed aste sali scendi Jacuzzi®.

To be combined with Jacuzzi® handheld shower and riser rail.

JACUZZI EUROPE S.p.A.

Socio Unico  
Direzione e Coordinamento  
Jacuzzi Brands, Corp. (USA)  
S.S. Pontebbana Km 97,200  
33098 Valvasone (PN) Italia  
Tel. +39-0434-859111  
Fax +39-0434-85278  
www.jacuzzi.eu  
e-mail: info@jacuzzi.it

JACUZZI BATHROOM ESPAÑA S.L.

Sociedad unipersonal  
A Company of  
Jacuzzi Brands, Corp. (USA)  
Ausias Marc, 157-159  
Graner, local A  
08013 Barcelona, España  
Telf. 932385031 - 932384162  
Fax 932385032 - 932722149  
www.jacuzzi.eu  
e-mail: info-es@jacuzzi.it

JACUZZI WHIRLPOOL GmbH

Humboldtstr. 30/32  
D-70771 Leinfelden-Echterdingen  
Deutschland  
Tel. 0049 (0)711 933247-40  
Fax 0049 (0)711 933247-50  
www.jacuzzi.eu  
e-mail: info-de@jacuzzi.it



I dati e le caratteristiche indicate non impegnano la Jacuzzi Europe Spa, che si riserva il diritto di apportare delle modifiche ritenute opportune senza obbligo di preavviso o di sostituzione.

The data and features given are in no way binding for the Jacuzzi S.p.A. company that is entitled to make any modification it deems suitable with no obligation of prior notice or substitution.

Die Daten und die angegebenen Produkteigenschaften sind für Jacuzzi S.p.A. keinesfalls verbindlich. Jacuzzi S.p.A. behält sich das Recht vor, ohne vorhergehende Mitteilung oder Ersatzansprüche für notwendig erachtete Änderungen durchzuführen.

Les données et les caractéristiques indiquées n'engagent pas la société Jacuzzi S.p.A. qui se réserve le droit d'apporter les modifications qu'elle jugera nécessaires sans obligation de préavis ni de remplacement.



