

sanitari e rubinetterie sanitaryware and tapware





C'è un solo marchio riconosciuto in tutto il mondo come leader globale nel settore dei prodotti di lusso, tecnologicamente avanzati, per il bagno e la spa. Questo marchio è Jacuzzi®. Perché solo Jacuzzi® ha creato l'idromassaggio, geniale e avveniristica intuizione tutta italiana del 1956, e lo ha fatto diventare una consuetudine di benessere per milioni di persone. E solo Jacuzzi®, ancora oggi, è la vera ed originale esperienza di benessere che ogni anno si rinnova, con più di 300 brevetti, una gamma completa di prodotti ed un'unica mission: fare dell'eccellenza una sfida quotidiana per offrire la miglior esperienza di wellness.

There is only one brand recognised throughout the world as a global leader in the sector of luxury, technologically advanced products for the bath and spa. We are talking about the Jacuzzi® brand. Because no other than Jacuzzi® created the hydromassage, a brilliant and futuristic, all-Italian intuition that dates back to 1956, and made it become a wellness habit for millions of people. Even today, Jacuzzi® is the only real and original wellness experience that is renovated every year with more than 300 patents, a complete range of products and just one mission: to turn excellence into a daily challenge capable of offering the utmost in wellness.

# il benessere Jacuzzi: dall'esperienza nasce un nuovo stile di vita.

Wellbeing by Jacuzzi®: from experience a new lifestyle is born.

Con Jacuzzi®, il benessere prende forma. Quando una gamma di prodotti è ispirata al più alto senso di wellness, nasce una collezione di vere esperienze uniche: esperienze da vivere in prima persona, sulla propria pelle, in cui immergersi per ritrovare il piacere della cura di sé. Per Jacuzzi®, è questo il vero senso del benessere: scegliere di vivere i propri spazi, anche i più intimi, come ricerca ed espressione del proprio stile di vita. Quando il benessere prende forma, solo allora l'esperienza Jacuzzi® ha raggiunto la sua perfetta dimensione.

Wellness takes shape with Jacuzzi®. When a range of products is inspired by the highest sense of wellness, a collection of real and unique experiences is born: very personal experiences that are felt on one's skin, experiences in which one can immerse oneself to recover the pleasure of self care. For Jacuzzi®, this is the real meaning of wellness: the choice of experiencing one's spaces, even the most intimate ones, as a pursuit and an expression of one's lifestyle. The experience of Jacuzzi® reaches its perfect dimension only when wellness takes shape.







## **Jacuzzi®** sanitari e rubinetterie sanitaryware and tapware

<b>sanitari</b> sanitaryware	8	<b>rubinetterie</b> tapware	82
infinito	10	morphosis	84
moove	16	aura	90
morphosis	22	young	96
nexus	28		
J4	36		
veya	44		
bordo	50		
cognito	56		

## Jacuzzi® sanitari sanitaryware

Il bagno è cambiato, non è più una stanza di servizio, è un mondo. Un universo da abitare, che racconta lo stile di vita di chi lo elegge a luogo deputato alla cura di sé. Per questo deve suggerire ai sensi, parlare alla ragione, accogliere istanze e accompagnare gesti. Per farlo, ogni dettaglio deve essere curato, ogni forma ricercata, ogni funzione perfetta. Tutte le caratteristiche che rendono eccellente la qualità dei sanitari Jacuzzi®.

The bathroom has changed, it is no longer a mere washroom, but has become world. A world to live in, that talks about the lifestyle of those who choose it as a place dedicated to self care. This is why it must talk to the senses, talk to rationality, fulfil desires and accompany gestures. To achieve its purpose, every detail must be taken care of, every shape must be refined, every function perfect. All these features make the quality of Jacuzzi® sanitaryware excellent.



Igiene brillante: la ceramica Jacuzzi® mantiene inalterata nel tempo la sua brillantezza, è inattaccabile dai comuni agenti fisici e chimici e assicura la massima igiene grazie all'assoluta mancanza di porosità e al trattamento Pure Glaze™.

Soft Close Seat e cerniere estraibili: grazie a un esclusivo sistema il sedile si chiude dolcemente e senza fare rumore. Mentre le speciali cerniere consentono di rimuovere e riposizionare in pochi attimi il sedile facilitandone la pulizia. Il trattamento antibatterico sulla seduta combatte la diffusione di batteri nocivi per un'igiene totale.

Brilliant hygiene: the ceramic ware by Jacuzzi® maintains its brilliance unaltered in the course of time, remains unaltered by common physical and chemical agents and ensures utmost hygiene thanks to its absolute lack of porosity and to the Pure Glaze™ treatment.

Soft Close Seat and pullout hinges: thanks to an exclusive system the seat shuts softly and silently. While the special hinges allow you to remove the seat for cleaning purposes and put it back in place in just a few minutes. The antibacterial treatment on the seat fights the diffusion of harmful bacteria for total hygiene.









**Jacuzzi** infinito

## Jacuzzi® infinito lavabo washbasin

Il design continua all'infinito: un concept esclusivo firmato Jacuzzi®: Techstone, materiale di nuovissima concezione, incontra la purezza formale del design di Carlo Urbinati e la stimolazione multisensoriale prende forma in una versione essenziale, inaspettata. La forma richiama la corolla di un fiore che si apre verso il cielo, accogliendo l'acqua che arriva dall'alto.

Design continues infinitely: an exclusive concept signed by Jacuzzi®. Techstone, a brand new material encounters the formal purity of Carlo Urbinati's design and multi-sensorial stimulation takes shape in an essential, minimalist way. The shape reminds one of the petals of a flower that open up towards the sky to capture the water that rains down upon it.







## Jacuzzi® infinito lavabo washbasin

design Carlo Urbinati

dimensioni: 70x40x20h cm

materiale: Techstone

dimensions: 70x40x20h cm

material: Techstone

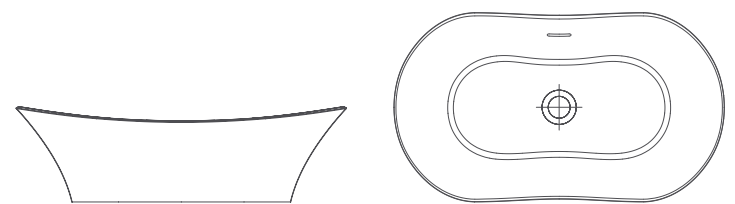

Forme estetiche coordinate: il lavabo Infinito richiama le forme della vasca con cui forma un tutt'uno concettuale, esprimendo l'esigenza di dare carattere e personalità all'ambiente, e di fare del bagno uno spazio dallo stile unico, personale.

Coordinated aesthetic shapes: the Infinito washbasin recalls the shape of the bath with which it forms a single concept to improve the character and personality of the environment and turn the bathroom into a space with a unique and personal style.









**Jacuzzi**. moove

Jacuzzi



## Jacuzzi® moove lavabo washbasin

design Marco Piva

**Dal punto allo spazio:** Moove è la nuova famiglia di lavabi dalle linee innovative e ricercate, capaci di combinare l'estetica più raffinata con un'intelligente ergonomia. Con la firma di Marco Piva continua il leitmotiv dell'ondulamento della materia sul piano, offrendo l'esperienza di un design capace di ispirare i sensi.

**Uno stile unico:** il lavabo Moove arricchisce il momento della cura di sé di nuove emozioni che coinvolgono tutti i gesti legati all'acqua: non più contenitori, ma movimenti della materia.

**Una linea coordinata:** il lavabo rimanda idealmente al design della vasca e si coordina perfettamente con il disegno del piatto doccia. su un piano in techstone bianco si fa spazio una forma organica ovale capace di esaltare le caratteristiche percettive del materiale.

From small to large: Moove is the new family of washbasins that boasts innovative and refined lines, capable of combining the most tasteful aesthetics with intelligent ergonomics. The leitmotiv of undulating surface matter continues under the creativity of Marco Piva, offering the experience of a design capable of inspiring the senses.

A unique style: the Moove washbasin adds new emotions, that involve all the gestures connected to water, to the time spent in self care: no longer storage units, but matter in movement.

A coordinated line: the washbasin refers ideally to the design of the bath and is perfectly coordinated with the shower tray. An organic, oval shape makes its way on a white Techstone surface and sets off the perceptive features of the material.

**lavabo 120x50 cm mobile senza cassetto (versione dx/sx)**

120x50 cm basin without drawer (rh/lh version)



**lavabo 120x50 cm mobile con cassetto (versione dx/sx)**

120x50 cm basin with drawer (rh/lh version)



Un sistema modulare: per inserirsi perfettamente in ogni tipo di spazio, il lavabo Moove si può configurare all'interno di un sistema che consente di ottenere 21 diverse soluzioni, combinando diverse posizioni, dimensioni e allestimenti.

Massima versatilità: il lavabo Moove è disponibile in più versioni: con mobile provvisto di cassetto oppure con mobile senza cassetto; entrambi finitura bianco laccato lucido o nero laccato lucido. Moove è inoltre proposto nella versione semi-incasso, abbinabile a qualunque tipo di elemento d'arredo.

A modular system: the Moove washbasin can be shaped within a system that offers 21 different solutions by combining various positions, dimensions and versions.

Utmost versatility: the Moove washbasin is available in various versions: in a unit provided with a drawer or without a drawer; both with a gloss lacquered white or gloss lacquered black finish.

Moove is also available in the semi-recessed version that can be fitted in any type of unit.















**Jacuzzi** morphosis

## Jacuzzi® morphosis

design Pininfarina

L'ambiente si trasforma: sensualmente scolpite nella ceramica, le linee di Morphosis si ispirano alla natura: foglia, conchiglia, grembo, polla d'acqua. Un esempio attualissimo di "organic design" che porta la firma esclusiva di Pininfarina. La purezza formale richiama la tecnologia più avanzata ed esprime il concept di arredo contemporaneo Jacuzzi® e trasforma sia visivamente che fisicamente l'ambiente bagno.

Coordinati per il benessere: la serie completa dei sanitari, lavabi, vasi e bidet, consente di creare un ambiente affine alla propria personalità, con uno stile omogeneo, in sintonia con gli altri spazi "living" della casa. La loro brillantezza esalta i complementi di arredo creando giochi di armonie e contrasti.

Slow Running Waste: con questo esclusivo sistema, installato al posto del tradizionale foro per il troppo pieno, basta una semplice rotazione per regolare la quantità d'acqua scaricata dal lavabo.

The environment is transformed: sensually sculptured in ceramic, the lines of Morphosis are inspired by nature: a leaf, a shell, the womb, a pool of water. A very modern example of organic design that bears the exclusive signature of Pininfarina. Formal purity attracts the most advanced technology that expresses the contemporary furnishing concept of Jacuzzi® and transforms the bathroom both visually and physically.

Coordinates for wellness: the complete line of sanitaryware, basins, W/C pans and bidets allows you to create an environment that is in tune with your personality with a consistent style that is in harmony with the other rooms in the home. Their brilliance sets off the complementary items and creates harmonious and contrasting effects.

Slow Running Waste: thanks to the innovative and functional Slow Running Waste system and in line with their refined aesthetics, none of the models of the Morphosis line are fitted with the traditional and unsightly overflow.



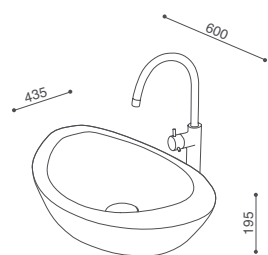

lavabo 60 cm  
60 cm basin

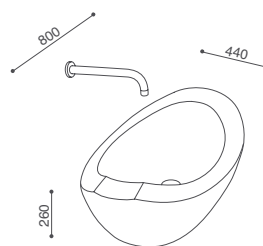

lavabo 80 cm  
80 cm basin



# Jacuzzi® morphosis

design Pininfarina

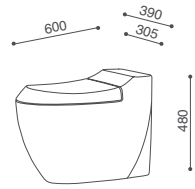

vaso a terra a filo parete  
floor-standing back-to-wall wc pan

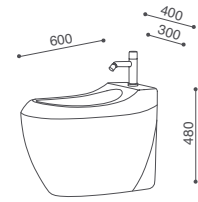

bidet a terra a filo parete  
floor-standing back-to-wall bidet





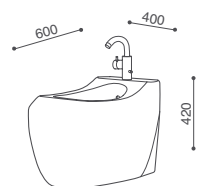

bidet sospeso  
wall-mounted bidet

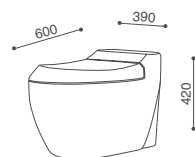

vaso sospeso  
wall-mounted wc pan









Jacuzzi

Jacuzzi® nexus

## Jacuzzi® nexus

Quello che mancava al bagno: Nexus è un concept originale, innovativo, in cui ogni elemento fa parte di una soluzione estetica unica. Nexus consente di personalizzare la zona bagno in modo esclusivo, secondo le ultime tendenze dell'arredo contemporaneo. Eleganza, semplicità, funzionalità, unicità: le sue caratteristiche ispirano benessere, armonia del corpo e dello spirito.

Un progetto coordinato: lavabi, bidet e vasi si integrano e completano a vicenda, fondendo un design inconfondibile creato con forme geometriche, pulite e complementari.

What was missing from the bathroom: Nexus is an original, innovative concept in which every element is part of a unique, aesthetic solution. Nexus allows you to customise the bathroom in an exclusive way in line with the latest contemporary furnishing trends. Elegance, simplicity, functionality and uniqueness: their features inspire wellbeing and harmony of body and spirit. A coordinated project: basins, bidets and WC pans integrate and complete each other, blending into an unmistakable design created using clean-cut and complementary geometric shapes.



Una tecnologia originale: l'innovativo sistema di scarico è brevettato Jacuzzi®: l'acqua scorre liberamente attorno a una cover rettangolare che nasconde lo scarico ed è fornita insieme ad ogni prodotto nelle varianti di colore rosso, nero, bianco e cromo, per offrire la possibilità di scegliere quella che si intona meglio ai colori del bagno. Da abbinare alla rubinetteria con salterello.

Forme ergonomiche: l'ergonomia avanzata delle forme, la funzionalità della seduta soft-close e l'igiene garantita dal trattamento antibatterico delle superfici, rendono Nexus una linea di prodotti veramente unica.

An original technology: the innovative drainage system is patented by Jacuzzi®: the water flows freely around a rectangular cover that conceals the drain and is supplied with each product in red, black, white or chrome to offer you the possibility of choosing the colour that best suits your bathroom. To be used with tapware fitted with a pop-up waste kit.

Ergonomic shapes: the advanced ergonomics of the shapes, the functionality of the soft-close seat and the hygiene guaranteed by the antibacterial surface treatment turn Nexus into a really unique product line.



## Jacuzzi® nexus

design Jacuzzi UK design studio

Nota: le rubinetterie utilizzate nelle immagini sono a solo scopo descrittivo  
 Note: the tapware shown in the photos is purely descriptive

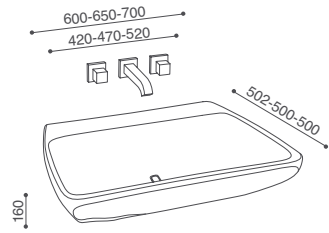

lavabo 60-65-70 cm d'appoggio  
 60-65-70 cm countertop basin

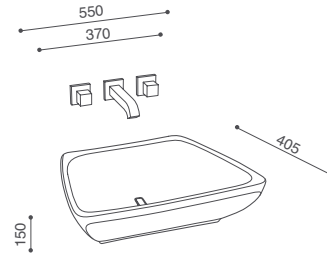

lavabo 55 cm d'appoggio  
 55 cm countertop basin



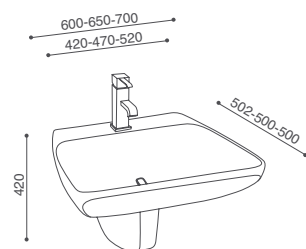

lavabo 60-65-70 cm con semi colonna  
60-65-70 basin with semi-pedestal

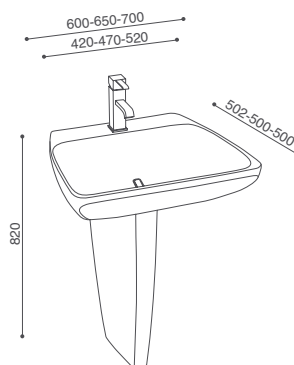

lavabo 60-65-70 cm con colonna  
60-65-70 basin with pedestal



# Jacuzzi® nexus

design Jacuzzi UK design studio

Nota: le rubinetterie utilizzate nelle immagini sono a solo scopo descrittivo  
 Note: the tapware shown in the photos is purely descriptive

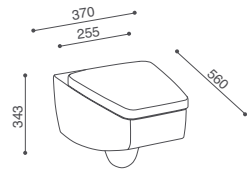

vaso sospeso  
 wall-mounted wc pan

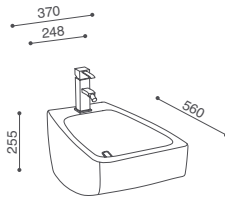

bidet sospeso  
 wall-mounted bidet

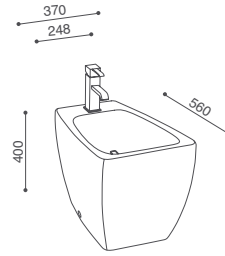

bidet a terra a filo parete  
 floor-standing back-to-wall bidet





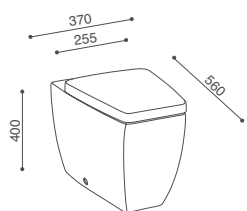

**vaso a terra a filo parete**  
 floor-standing back-to-wall wc pan

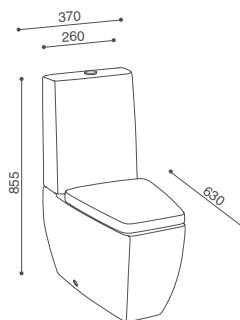

**vaso a terra monoblocco con cassetta**  
 close coupled floor-standing wc pan with cistem









Jacuzzi J4

## Jacuzzi® J4

design Jacuzzi UK design studio

Raffinatezza e spontaneità del vivere: il fascino sottile del design contemporaneo e della tecnologia Jacuzzi®, ovvero la ricerca estetica nella funzionalità. Con J4 prende forma la perfezione di una collezione di elementi architettonici dedicata allo spazio per rigenerarsi, un ambiente abitato dalla luce e dal benessere.

Una personalità inconfondibile: la forma dei lavabi J4 è studiata per raggiungere la massima profondità e capienza in uno spazio ottimale. Un comfort che si aggiunge alla possibilità di scegliere fra diverse soluzioni: sospeso, con colonna, con semi colonna, bacinella lavamani. Una versatilità che si coordina alle diverse soluzioni del vaso e del bidet.

A refined and spontaneous lifestyle: the subtle charm of contemporary design and of technology by Jacuzzi®, i.e. aesthetic research into functionality. The perfection of a collection of architectural elements dedicated to a revitalising space, a place soaked in light and wellness, takes shape with J4.

An unmistakable personality: the shape of the J4 basins has been studied to achieve the greatest depth and capacity in an optimal space. A comfort that is added to the possibility of choosing from various versions: wall-mounted, pedestal, half-pedestal and handrinse basins. A versatility that is coordinated with the various WC pan and bidet options.



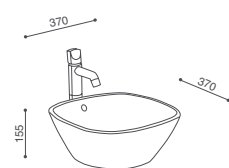

bacinella d'appoggio  
countertop bowl

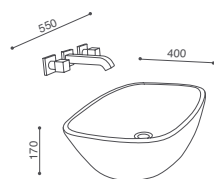

lavabo 55 cm d'appoggio  
55 cm countertop basin

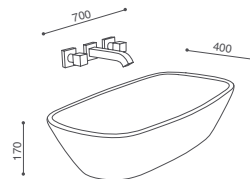

lavabo 70 cm d'appoggio  
70 cm countertop basin



# Jacuzzi J4

design Jacuzzi UK design studio

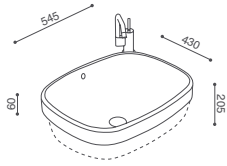

vanity  
vanity basin

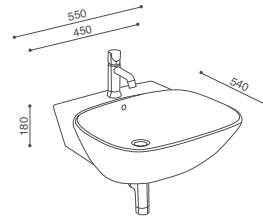

lavabo 55 cm sospeso  
55 cm wall-mounted basin





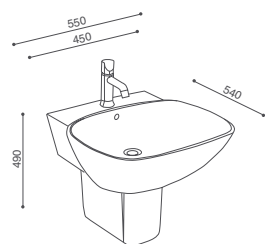

lavabo 55 cm con semi colonna  
55 cm basin with semi-pedestal

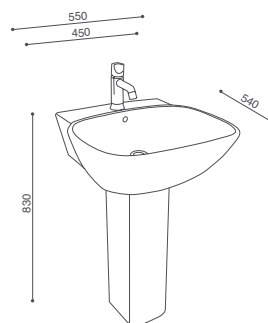

lavabo 55 cm con colonna  
55 cm basin with pedestal



# Jacuzzi J4

design Jacuzzi UK design studio

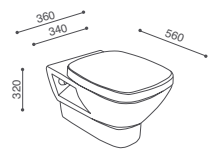

vaso sospeso  
wall-mounted wc pan

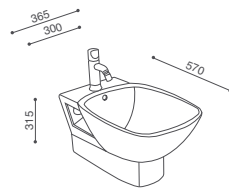

bidet sospeso  
wall-mounted bidet

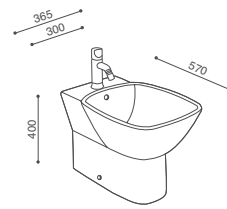

bidet a terra a filo parete  
floor-standing back-to-wall bidet



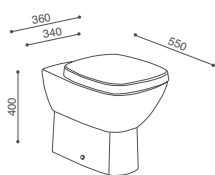

vaso a terra a filo parete  
floor-standing back-to-wall wc pan

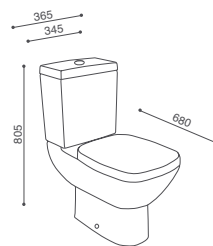

vaso a terra monoblocco con cassetta  
close coupled floor-standing wc pan with cistem









**Jacuzzi**® veya

## Jacuzzi® veyá

design Jacuzzi UK design studio

Il prestigio del design: una linea estetica distintiva, forme organiche, profili eleganti: Veya viene incontro ai gusti più raffinati con una gamma completa di soluzioni coordinate. Il suo design contemporaneo consente di personalizzare lo spazio bagno con stile e raffinatezza.

Le caratteristiche dell'eccellenza: Veya rispetta tutti gli standard di qualità, dalla perfetta ergonomia, al trattamento Pure Glaze™ alla seduta Soft Close, ai fissaggi nascosti, alla massima funzionalità dei lavabi in tutte le versioni. L'innovativo scarico Praxis, brevettato da Jacuzzi®, consente di azionare lo scarico attraverso una semplice pressione sul tappo del troppo pieno: un mix perfetto di funzionalità e design.

The prestige of design: a distinctive aesthetic line, organic shapes, elegant profiles: Veya meets the most refined tastes with a complete range of coordinated ideas. Its contemporary design allows you to customise the bathroom in a stylish and refined way.

The features of excellence: Veya respects all quality standards, from perfect ergonomics to the Pure Glaze™ treatment and the Soft Close seat, to concealed fixings, and, lastly, to the utmost functionality of the basins in all versions. The innovative Praxis drain patented by Jacuzzi® allows you to drain the water by simply pressing the overflow plug: a perfect blend of functionality and design.



lavabo da 46 cm con semi colonna  
46 cm basin with semi-pedestal



lavabo 60 cm d'appoggio  
60 cm countertop basin



**Jacuzzi** veyá

design Jacuzzi UK design studio

lavabo da 63 cm con colonna (disponibile anche con semi colonna)  
63 cm basin with pedestal (also available with semi-pedestal)



vaso a terra a filo parete  
floor-standing back-to-wall wc pan





bidet a terra a filo parete  
floor-standing back-to-wall bidet

vaso a terra monoblocco con cassetta  
close coupled floor-standing wc pan with cistem

vaso sospeso  
wall-mounted wc pan

bidet sospeso  
wall-mounted bidet









**Jacuzzi** bordo



## Jacuzzi® bordo

design Jacuzzi UK design studio

La semplicità è un classico: se si pensa a una gamma di soluzioni dallo stile contemporaneo, che offra tantissime misure, combinazioni e possibilità d'installazione, versatile nell'offerta, semplice da installare, il suo nome è Bordo. Difficile immaginare una proposta più completa, con lo stesso standard di qualità e la stessa cura dei dettagli.

La bellezza delle superfici: la ceramica dei sanitari Bordo Jacuzzi® è luminosa, brillante e facile da pulire e dall'igiene durevole, grazie al trattamento Pure Glaze™.

Simplicity is a classic: if you are thinking of a range of contemporary style sanitaryware that is available in many sizes, combinations and installation possibilities, versatile in its options and simple to install, you are thinking of Bordo. It's difficult to imagine a more complete line having the same quality standard and the same care for details.

The beauty of surfaces: the ceramics of the Bordo sanitaryware by Jacuzzi® is luminous, shiny and easy to clean as well as offering durable hygiene thanks to the Pure Glaze™ treatment.

lavabo 45 cm da appoggio

45 cm countertop basin



lavabo 55 cm sospeso (disponibile anche con semi colonna, colonna o d'appoggio)

55 cm wall-mounted basin (also available with semi-pedestal, pedestal or countertop)



Dettagli di stile: la personalità di Bordo è eclettica, curata nei particolari come, ad esempio, l'elegante copertura personalizzata con il marchio Jacuzzi® che nasconde l'antiestetico foro del troppo pieno, o la seduta Soft Close per un comfort ottimale.

Stylish details: Bordo has an eclectic personality that is taken care of in every detail; for example, take the elegant, customised, Jacuzzi® branded cover that conceals the unsightly overflow, or the Soft Close seat designed for optimal comfort.

lavabo da 60 cm con colonna (disponibile anche con semi colonna o sospeso)  
60 cm basin with pedestal (also available with semi-pedestal or wall-mounted)



vaso sospeso  
wall-mounted wc pan



bidet sospeso  
wall-mounted bidet



bidet a terra a filo parete  
floor-standing back-to-wall bidet



vaso a terra a filo parete  
floor-standing back-to-wall wc pan

vaso a terra monoblocco con cassetta  
close coupled floor-standing wc pan with cistern









**Jacuzzi** cognito



## Jacuzzi® cognito

design Jacuzzi UK design studio

La perfezione asimmetrica: una gamma completa dal disegno distintivo a forma di goccia, morbidamente asimmetrica, originale, dalla forte personalità. Per un bagno coordinato, che suggerisce emozioni, dedicato a uno stile di vita creativo.

Uno stile versatile: lavabi, bidet, vasi, tutti coordinati, con tante soluzioni per dimensioni e tipologia di installazione, tutti con il trattamento Pure Glaze™ per un'igiene perfetta. Originale ed esclusiva la soluzione per il troppo pieno, con un tappo personalizzato dal logo Jacuzzi®.

Asymmetrical perfection: a complete range with a distinctive teardrop design, softly asymmetrical, original and with a strong personality. For a coordinated bathroom that suggests emotions and is dedicated to a creative lifestyle.

A versatile style: the basins, bidets and WC pans are all coordinated with lots of options in terms of dimensions and types of installation and are all supplied with the Pure Glaze™ treatment for perfect hygiene. The overflow solution with the Jacuzzi® logo is both original and exclusive.



lavabo da 44 cm d'appoggio  
44 cm countertop basin



lavabo da 55-60-70 cm con colonna (disponibile da 55-60 cm anche con semi colonna o sospeso)  
55-60-70 cm basin with pedestal (55-60 cm also available with semi-pedestal or wall-mounted)



# Jacuzzi® cognito

design Jacuzzi UK design studio

vaso sospeso  
wall-mounted wc pan



bidet sospeso  
wall-mounted bidet



vaso a terra a filo parete  
floor-standing back-to-wall wc pan



bidet a terra a filo parete  
floor-standing back-to-wall bidet



vaso a terra monoblocco con cassetta  
close coupled floor-standing wc pan with cistern







# Jacuzzi® infinito

# Jacuzzi® moove



lavabo  
basin

materiale: Techstone  
material: Techstone

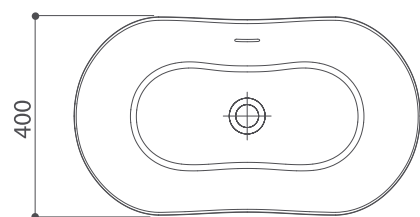
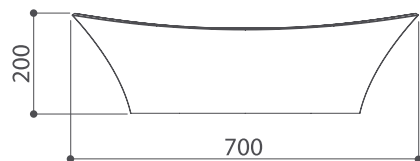

**DIMENSIONI**  
larghezza 70 cm  
profondità 40 cm  
altezza 20 cm

**DIMENSIONS**  
width 70 cm  
depth 40 cm  
height 20 cm



lavello 120x50 cm mobile con cassetto (versione dx/sx)  
120x50 cm basin with drawer (rh/lh version)

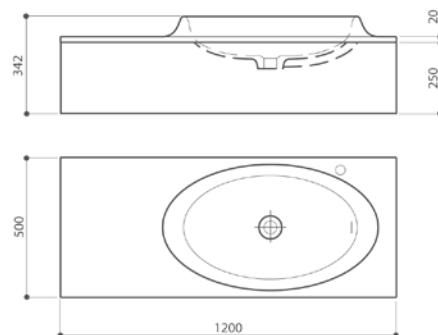

lavello 90x50 cm mobile con cassetto (versione unica)  
90x50 cm basin with drawer (single version)

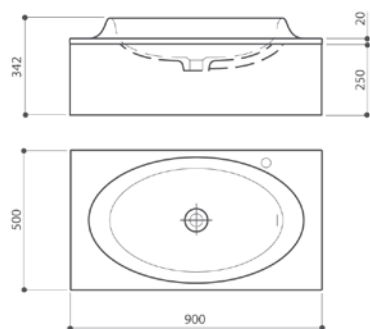

**DIMENSIONI**  
larghezza 120 cm  
profondità 50 cm  
altezza 34,2 cm  
fori 0/1

**DIMENSIONS**  
width 120 cm  
depth 50 cm  
height 34,2 cm  
holes 0/1

**DIMENSIONI**  
larghezza 90 cm  
profondità 50 cm  
altezza 34,2 cm  
fori 0/1

**DIMENSIONS**  
width 90 cm  
depth 50 cm  
height 34,2 cm  
holes 0/1



lavello 120x50 cm mobile senza cassetto (versione dx/sx)  
120x50 cm basin without drawer (rh/lh version)

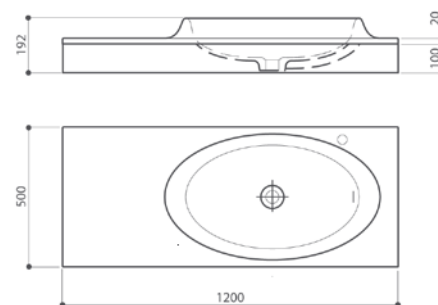

lavello 90x50 cm mobile senza cassetto (versione unica)  
90x50 cm basin without drawer (single version)

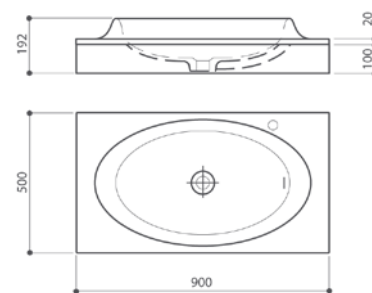

**DIMENSIONI**  
larghezza 120 cm  
profondità 50 cm  
altezza 19,2 cm  
fori 0/1

**DIMENSIONS**  
width 120 cm  
depth 50 cm  
height 19,2 cm  
holes 0/1

**DIMENSIONI**  
larghezza 90 cm  
profondità 50 cm  
altezza 19,2 cm  
fori 0/1

**DIMENSIONS**  
width 90 cm  
depth 50 cm  
height 19,2 cm  
holes 0/1

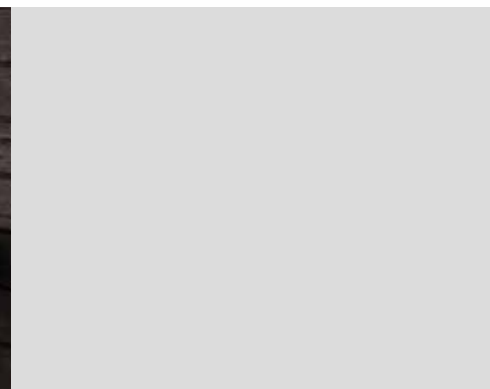

lavabo 70x45 cm a incasso  
70x45 cm recessed basin

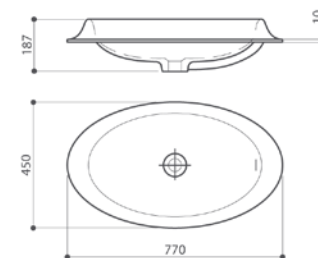

**DIMENSIONI**  
larghezza 77 cm  
profondità 45 cm  
altezza 18,7 cm  
fori 0

**DIMENSIONS**  
width 77 cm  
depth 45 cm  
height 18,7 cm  
holes 0

# Jacuzzi® morphosis



lavabo 80 cm  
80 cm basin

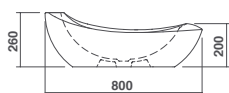
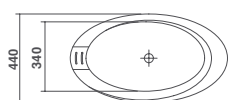

**DIMENSIONI**  
larghezza 80 cm  
profondità 44 cm  
altezza 26 cm  
fori 0

**DIMENSIONS**  
width 80 cm  
depth 44 cm  
height 26 cm  
holes 0

lavabo 60 cm  
60 cm basin

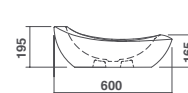
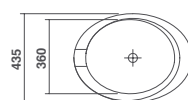

**DIMENSIONI**  
larghezza 60 cm  
profondità 43,5 cm  
altezza 19,5 cm  
fori 0

**DIMENSIONS**  
width 60 cm  
depth 43,5 cm  
height 19,5 cm  
holes 0

bidet a terra a filo parete  
floor-standing back-to-wall bidet

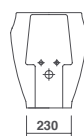
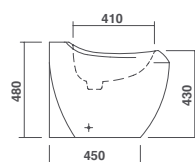
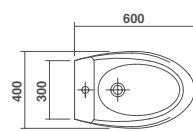

**DIMENSIONI**  
larghezza 60 cm  
profondità 60 cm  
altezza 48 cm  
fori 1

**DIMENSIONS**  
width 60 cm  
depth 60 cm  
height 48 cm  
holes 1

vaso a terra a filo parete  
floor-standing back-to-wall wc pan

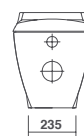
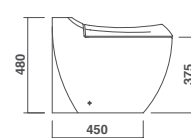
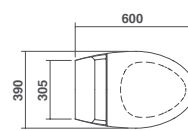

**DIMENSIONI**  
larghezza 39 cm  
profondità 60 cm  
altezza 48 cm

**DIMENSIONS**  
width 39 cm  
depth 60 cm  
height 48 cm

bidet sospeso  
wall-mounted bidet

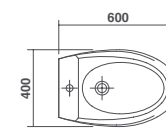

**DIMENSIONI**  
larghezza 40 cm  
profondità 60 cm  
altezza 42 cm-48 cm da terra  
fori 1

**DIMENSIONS**  
width 40 cm  
depth 60 cm  
height 42 cm-48 cm above the floor  
holes 1

vaso sospeso  
wall-mounted wc pan

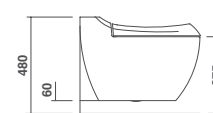
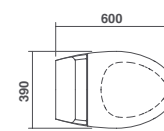

**DIMENSIONI**  
larghezza 39 cm  
profondità 60 cm  
altezza 42 cm-48 cm da terra

**DIMENSIONS**  
width 39 cm  
depth 60 cm  
height 42 cm-48 cm above the floor  
holes 1



# Jacuzzi® nexus



lavabo 60-65-70 cm con colonna  
60-65-70 cm basin with pedestal

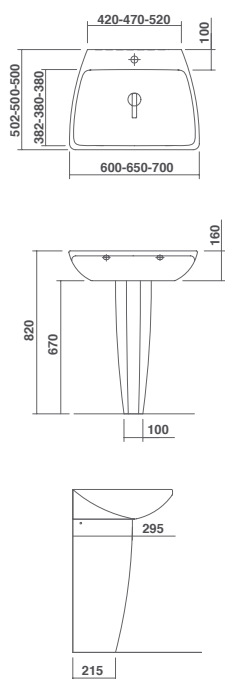

**DIMENSIONI**  
larghezza 60-65-70 cm  
profondità 50,2-50-50 cm  
altezza 82 cm  
fori 0 o 1

**DIMENSIONS**  
width 60-65-70 cm  
depth 50,2-50-50 cm  
height 82 cm  
holes 0 or 1

lavabo 60-65-70 cm con semi colonna  
60-65-70 cm basin with semi-pedestal

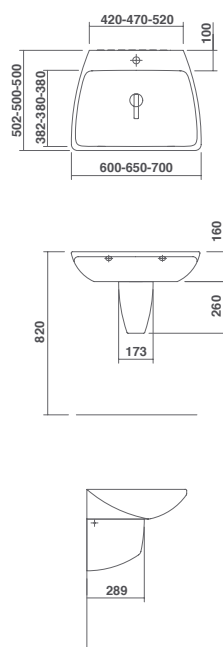

**DIMENSIONI**  
larghezza 60-65-70 cm  
profondità 50,2-50-50 cm  
altezza 42 cm  
fori 0 o 1

**DIMENSIONS**  
width 60-65-70 cm  
depth 50,2-50-50 cm  
height 42 cm  
holes 0 or 1

lavabo 60-65-70 cm d'appoggio  
60-65-70 cm countertop basin

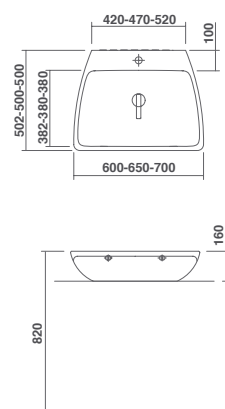

**DIMENSIONI**  
larghezza 60-65-70 cm  
profondità 50,2-50-50 cm  
altezza 16 cm  
fori 0 o 1

**DIMENSIONS**  
width 60-65-70 cm  
depth 50,2-50-50 cm  
height 16 cm  
holes 0 or 1

lavabo 55 cm d'appoggio  
55 cm countertop basin

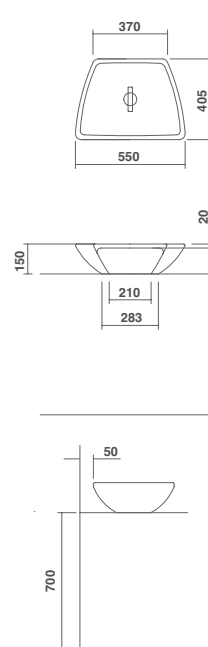

**DIMENSIONI**  
larghezza 55 cm  
profondità 40,5 cm  
altezza 15 cm  
fori 0

**DIMENSIONS**  
width 55 cm  
depth 40,5 cm  
height 15 cm  
holes 0

bidet sospeso  
wall-mounted bidet

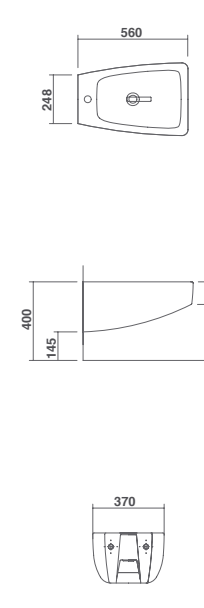

**DIMENSIONI**  
larghezza 37 cm  
profondità 56 cm  
altezza 25,5 cm-40 cm da terra  
fori 1

**DIMENSIONS**  
width 37 cm  
depth 56 cm  
height 25,5 cm-40 cm above the floor  
holes 1

vaso sospeso  
wall-mounted wc pan

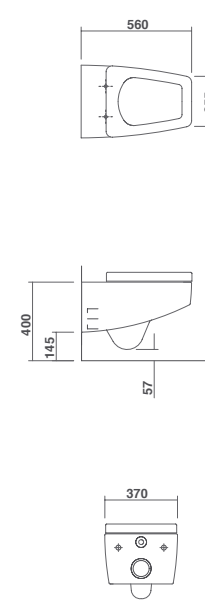

**DIMENSIONI**  
larghezza 37 cm  
profondità 56 cm  
altezza 25,5 cm-40 cm da terra

**DIMENSIONS**  
width 37 cm  
depth 56 cm  
height 25,5 cm-40 cm above the floor



bidet a terra a filo parete  
floor-standing back-to-wall bidet

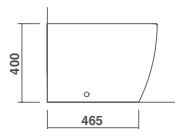
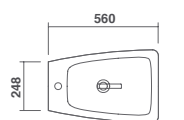

**DIMENSIONI**  
larghezza 37 cm  
profondità 56 cm  
altezza 40 cm  
fori 1

**DIMENSIONS**  
width 37 cm  
depth 56 cm  
height 40 cm  
holes 1

vaso a terra a filo parete  
floor-standing back-to-wall wc pan

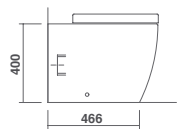
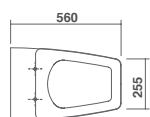

**DIMENSIONI**  
larghezza 37 cm  
profondità 56 cm  
altezza 40 cm

**DIMENSIONS**  
width 37 cm  
depth 56 cm  
height 40 cm

vaso a terra monoblocco con cassetta  
close coupled floor-standing wc pan  
with cistern

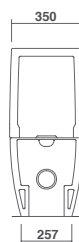
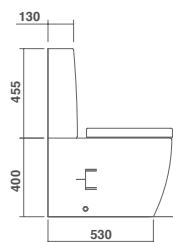
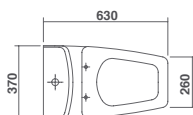

**DIMENSIONI**  
larghezza 37 cm  
profondità 63 cm  
altezza 85,5 cm

**DIMENSIONS**  
width 37 cm  
depth 63 cm  
height 85,5 cm

# Jacuzzi J4



lavabo 55 cm con colonna  
55 cm basin with pedestal

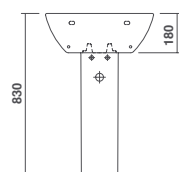
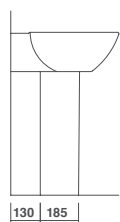
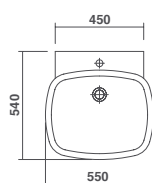

**DIMENSIONI**  
larghezza 55 cm  
profondità 54 cm  
altezza 83 cm  
fori 0 o 1

**DIMENSIONS**  
width 55 cm  
depth 54 cm  
height 83 cm  
holes 0 or 1

lavabo 55 cm con semi colonna  
55 cm basin with semi-pedestal

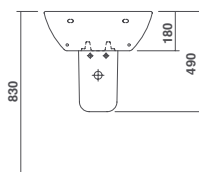
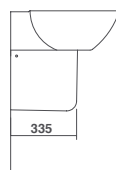
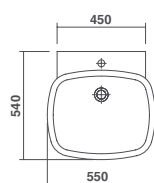

**DIMENSIONI**  
larghezza 55 cm  
profondità 54 cm  
altezza 49 cm  
fori 0 o 1

**DIMENSIONS**  
width 55 cm  
depth 54 cm  
height 49 cm  
holes 0 or 1

lavabo sospeso  
wall-mounted basin

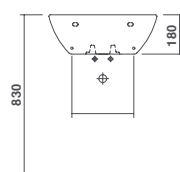
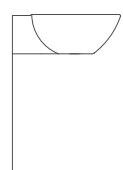
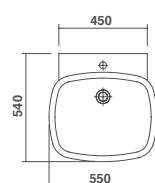

**DIMENSIONI**  
larghezza 55 cm  
profondità 54 cm  
altezza 18 cm  
fori 0 o 1

**DIMENSIONS**  
width 55 cm  
depth 54 cm  
height 18 cm  
holes 0 or 1

bacinella d'appoggio  
countertop bowl

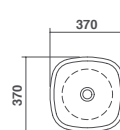

**DIMENSIONI**  
larghezza 37 cm  
profondità 37 cm  
altezza 17 cm  
fori 0

**DIMENSIONS**  
width 37 cm  
depth 37 cm  
height 17 cm  
holes 0

lavabo 55 cm d'appoggio  
55 cm countertop basin

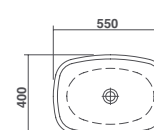

**DIMENSIONI**  
larghezza 55 cm  
profondità 40 cm  
altezza 17 cm  
fori 0

**DIMENSIONS**  
width 55 cm  
depth 40 cm  
height 17 cm  
holes 0

lavabo 70 cm d'appoggio  
70 cm countertop basin

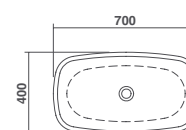

**DIMENSIONI**  
larghezza 70 cm  
profondità 40 cm  
altezza 17 cm  
fori 0

**DIMENSIONS**  
width 70 cm  
depth 40 cm  
height 17 cm  
holes 0



Vanity  
Vanity basin

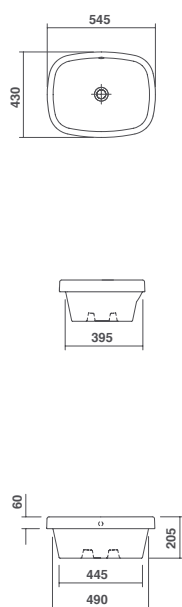

**DIMENSIONI**  
larghezza 54,5 cm  
profondità 43 cm  
altezza 20,5 cm  
fori 0

**DIMENSIONS**  
width 54,5 cm  
depth 43 cm  
height 20,5 cm  
holes 0

bidet sospeso  
wall-mounted bidet

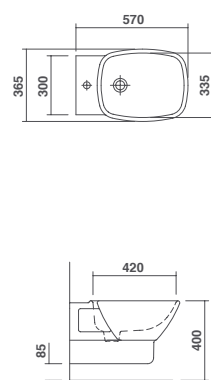

**DIMENSIONI**  
larghezza 36,5 cm  
profondità 57 cm  
altezza 31,5 cm-40 cm da terra  
fori 1

**DIMENSIONS**  
width 36,5 cm  
depth 57 cm  
height 31,5 cm-40 cm  
above the floor  
holes 1

vaso sospeso  
wall-mounted wc pan

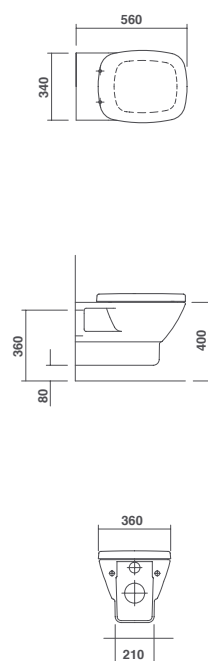

**DIMENSIONI**  
larghezza 36 cm  
profondità 56 cm  
altezza 32 cm-40 cm da terra

**DIMENSIONS**  
width 36 cm  
depth 56 cm  
height 32 cm-40 cm  
above the floor

bidet a terra a filo parete  
floor-standing back-to-wall bidet

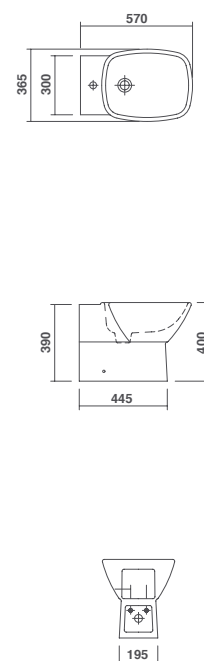

**DIMENSIONI**  
larghezza 36,5 cm  
profondità 57 cm  
altezza 40 cm  
fori 1

**DIMENSIONS**  
width 36,5 cm  
depth 57 cm  
height 40 cm  
holes 1

vaso a terra a filo parete  
floor-standing back-to-wall wc pan

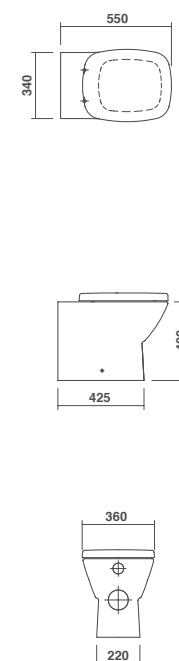

**DIMENSIONI**  
larghezza 36 cm  
profondità 55 cm  
altezza 40 cm

**DIMENSIONS**  
width 36 cm  
depth 55 cm  
height 40 cm

vaso a terra monoblocco con cassetta  
close coupled floor-standing wc pan  
with cistern

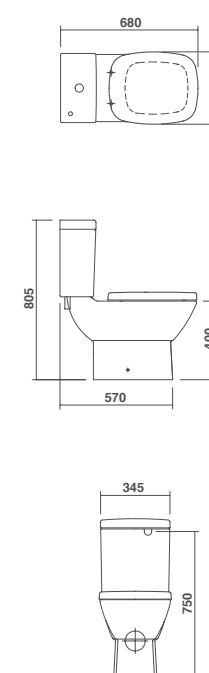

**DIMENSIONI**  
larghezza 36,5 cm  
profondità 68 cm  
altezza 80,5 cm

**DIMENSIONS**  
width 36,5 cm  
depth 68 cm  
height 80,5 cm



# Jacuzzi® veyá



lavabo da 46 cm con semi colonna  
46 cm basin with semi-pedestal

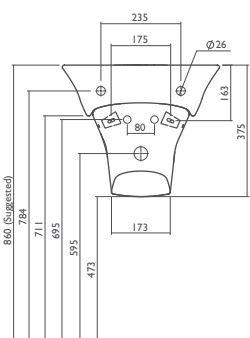
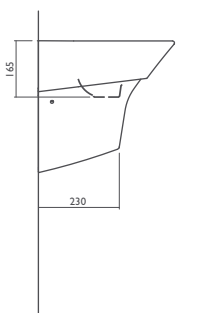
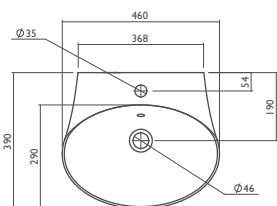

**DIMENSIONI**  
larghezza 46 cm  
profondità 39 cm  
altezza 37,5 cm  
fori 1

**DIMENSIONS**  
width 46 cm  
depth 39 cm  
height 37,5 cm  
holes 1

lavabo d'appoggio da 60 cm  
60 cm countertop basin

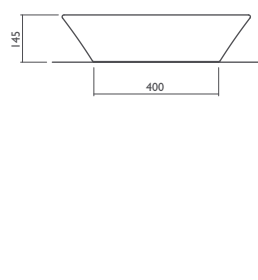
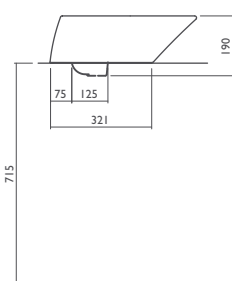
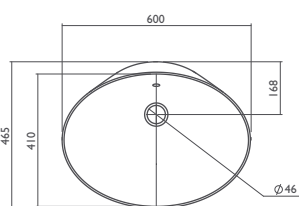

**DIMENSIONI**  
larghezza 60 cm  
profondità 46,5 cm  
altezza 14,5 cm  
fori 0

**DIMENSIONS**  
width 60 cm  
depth 46,5 cm  
height 14,5 cm  
holes 0

lavabo da 63 cm con semi colonna  
63 cm basin with semi-pedestal

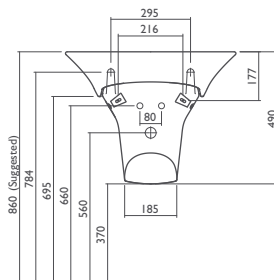
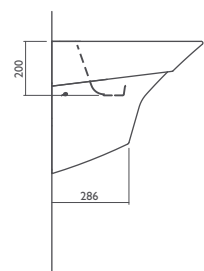
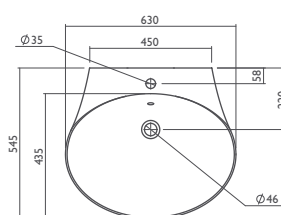

**DIMENSIONI**  
larghezza 63 cm  
profondità 54,5 cm  
altezza 49 cm  
fori 1

**DIMENSIONS**  
width 63 cm  
depth 54,5 cm  
height 49 cm  
holes 1

lavabo da 63 cm con colonna  
63 cm basin with pedestal

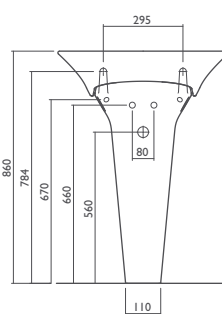
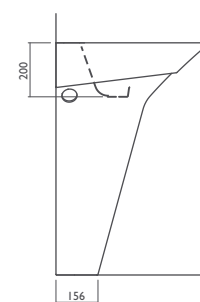
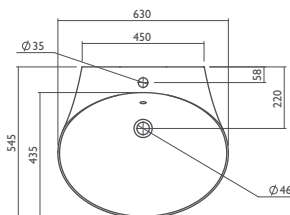

**DIMENSIONI**  
larghezza 63 cm  
profondità 54,5 cm  
altezza 86 cm  
fori 1

**DIMENSIONS**  
width 63 cm  
depth 54,5 cm  
height 86 cm  
holes 1

bidet sospeso  
wall-mounted bidet

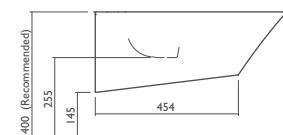
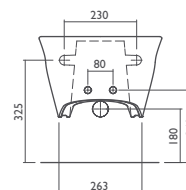
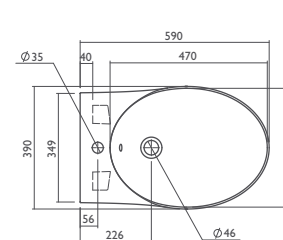

**DIMENSIONI**  
larghezza 39 cm  
profondità 59 cm  
altezza 40 cm da terra  
fori 1

**DIMENSIONS**  
width 39 cm  
depth 59 cm  
height 40 cm above the floor  
holes 1

vaso sospeso  
wall-mounted wc pan

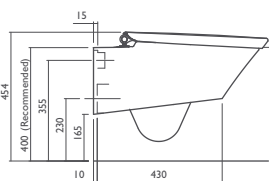
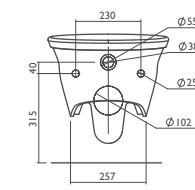
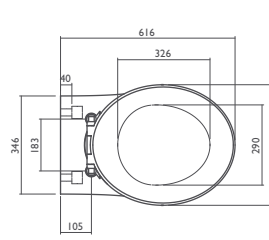

**DIMENSIONI**  
larghezza 42,5 cm  
profondità 61,6 cm  
altezza 40 cm da terra

**DIMENSIONS**  
width 42,5 cm  
depth 61,6 cm  
height 40 cm above the floor



bidet a terra a filo parete  
floor-standing back-to-wall bidet

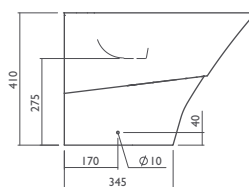
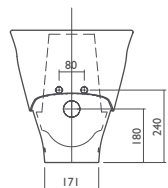
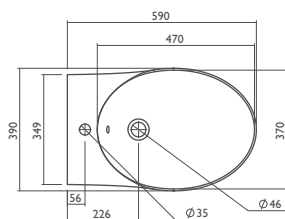

**DIMENSIONI**  
larghezza 39 cm  
profondità 59 cm  
altezza 41 cm  
fori 1

**DIMENSIONS**  
width 39 cm  
depth 59 cm  
height 41 cm  
holes 1

vaso a terra a filo parete  
floor-standing back-to-wall wc pan

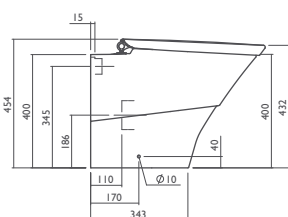
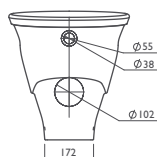
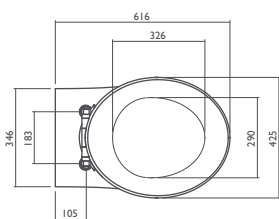

**DIMENSIONI**  
larghezza 42,5 cm  
profondità 61,6 cm  
altezza 40 cm

**DIMENSIONS**  
width 42,5 cm  
depth 61,6 cm  
height 40 cm

vaso a terra monoblocco con cassetta  
close coupled floor-standing wc pan  
with cistern

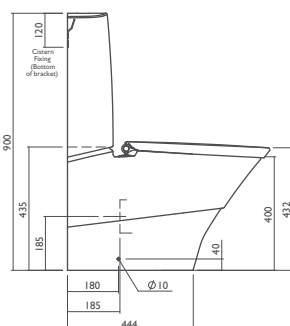
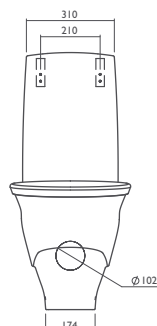
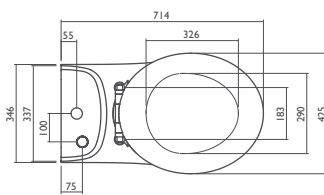

**DIMENSIONI**  
larghezza 42,5 cm  
profondità 71,4 cm  
altezza 90,7 cm con cassetta

**DIMENSIONS**  
width 42,5 cm  
depth 71,4 cm  
height 90,7 cm with cistern

# Jacuzzi® bordo

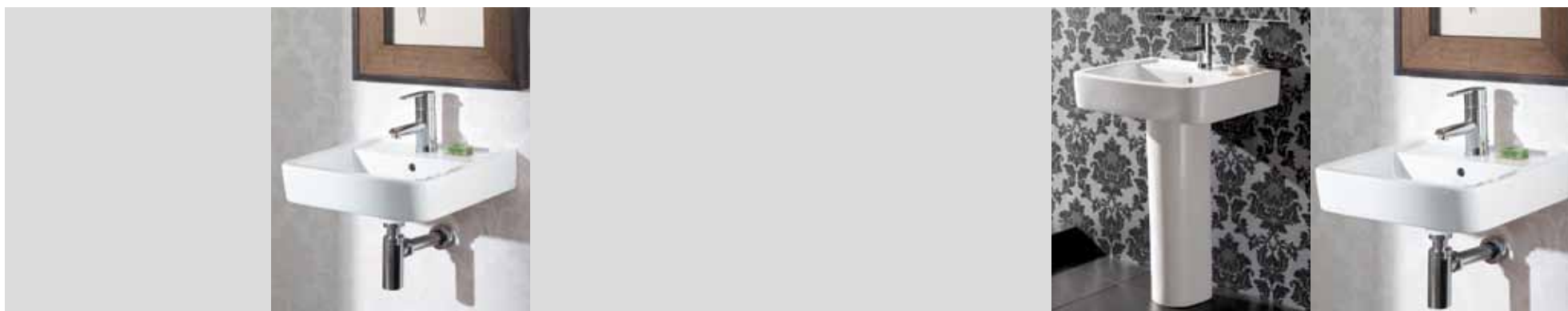

lavabo 45 cm d'appoggio  
45 cm countertop basin

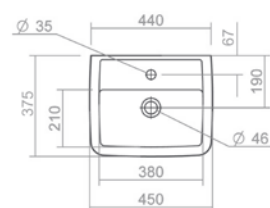

**DIMENSIONI**  
larghezza 45 cm  
profondità 37 cm  
altezza 16 cm  
fori 1

**DIMENSIONS**  
width 45 cm  
depth 37 cm  
height 16 cm  
holes 1

lavabo da 55 cm sospeso  
55 cm wall-mounted basin

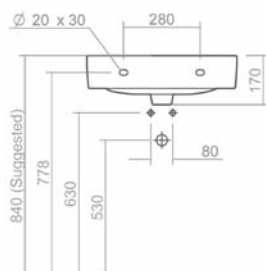
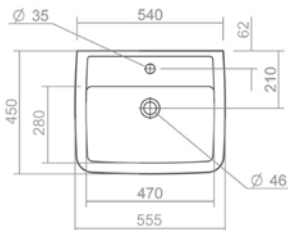

**DIMENSIONI**  
larghezza 55 cm  
profondità 46 cm  
altezza 17 cm  
fori 1

**DIMENSIONS**  
width 55 cm  
depth 46 cm  
height 17 cm  
holes 1

lavabo da 55 cm d'appoggio  
55 cm countertop basin

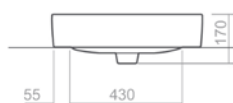
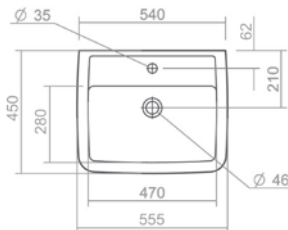

**DIMENSIONI**  
larghezza 55 cm  
profondità 46 cm  
altezza 17 cm  
fori 1

**DIMENSIONS**  
width 55 cm  
depth 46 cm  
height 17 cm  
holes 1

lavabo da 55 cm con semi colonna  
55 cm basin with semi-pedestal

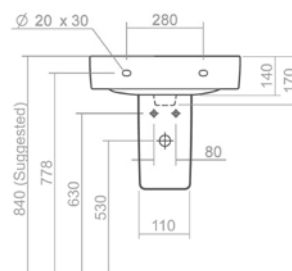
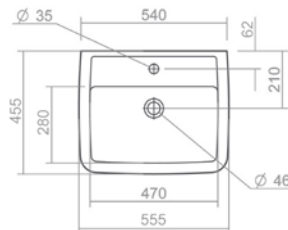

**DIMENSIONI**  
larghezza 55 cm  
profondità 46 cm  
altezza 45,5 cm  
fori 1

**DIMENSIONS**  
width 55 cm  
depth 46 cm  
height 45,5 cm  
holes 1

lavabo da 55 cm con colonna  
55 cm basin with pedestal

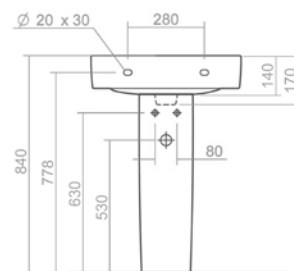
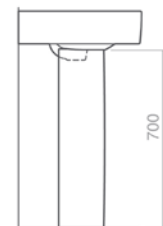
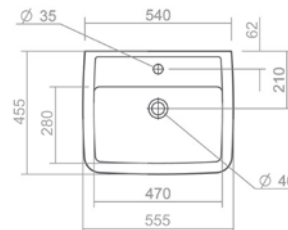

**DIMENSIONI**  
larghezza 55 cm  
profondità 46 cm  
altezza 84 cm  
fori 1

**DIMENSIONS**  
width 55 cm  
depth 46 cm  
height 84 cm  
holes 1

lavabo da 60 cm sospeso  
60 cm wall-mounted basin

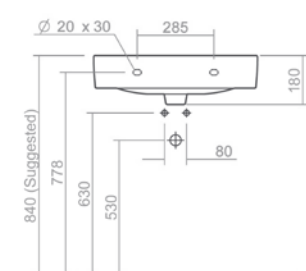
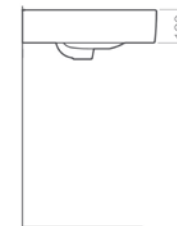
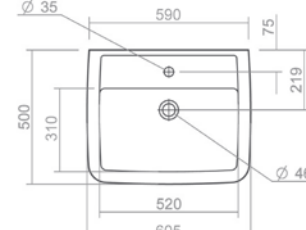

**DIMENSIONI**  
larghezza 60 cm  
profondità 50 cm  
altezza 18 cm  
fori 1

**DIMENSIONS**  
width 60 cm  
depth 50 cm  
height 18 cm  
holes 1



lavabo da 60 cm con semi colonna  
60 cm basin with semi-pedestal

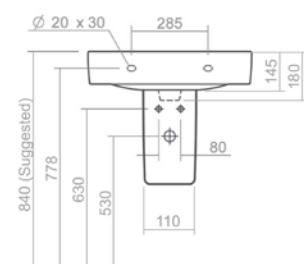
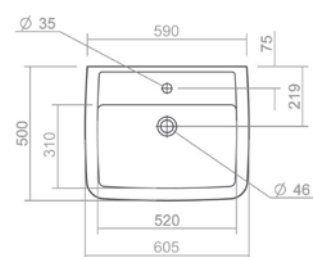

**DIMENSIONI**  
larghezza 60 cm  
profondità 50 cm  
altezza 45,5 cm  
fori 1

**DIMENSIONS**  
width 60 cm  
depth 50 cm  
height 45,5 cm  
holes 1



lavabo da 60 cm con colonna  
60 cm basin with pedestal

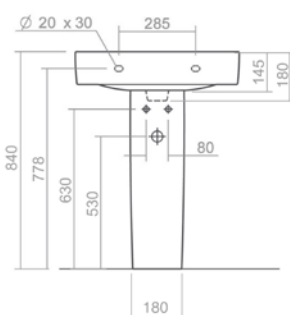
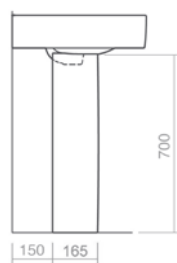
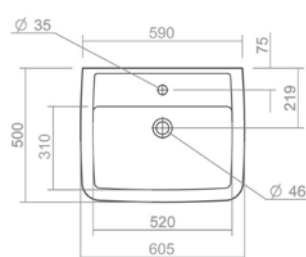

**DIMENSIONI**  
larghezza 60 cm  
profondità 50 cm  
altezza 84 cm  
fori 1

**DIMENSIONS**  
width 60 cm  
depth 50 cm  
height 84 cm  
holes 1



# Jacuzzi® bordo



bidet sospeso  
wall-mounted bidet

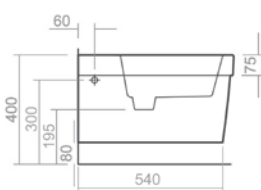
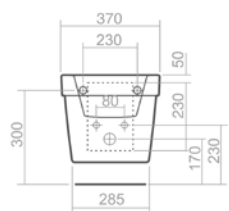
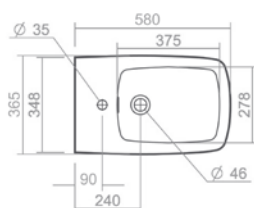

**DIMENSIONI**  
larghezza 36,5 cm  
profondità 58 cm  
altezza 40 cm da terra  
fori I

**DIMENSIONS**  
width 36,5 cm  
depth 58 cm  
height 40 cm above the floor  
holes I

vaso sospeso  
wall-mounted wc pan

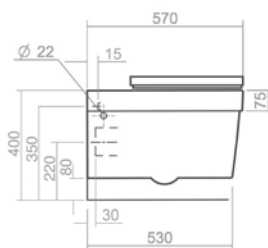
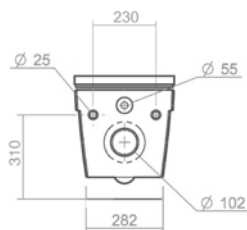
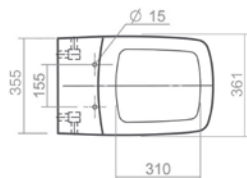

**DIMENSIONI**  
larghezza 36 cm  
profondità 57 cm  
altezza 40 cm da terra

**DIMENSIONS**  
width 36 cm  
depth 57 cm  
height 40 cm above the floor

bidet a terra a filo parete  
floor-standing back-to-wall bidet

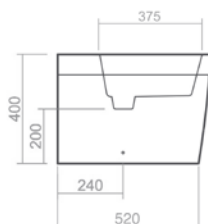
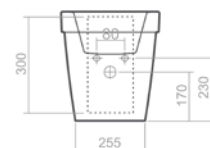
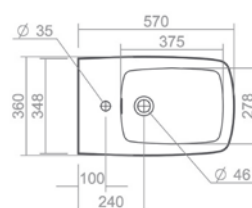

**DIMENSIONI**  
larghezza 56 cm  
profondità 57 cm  
altezza 40 cm  
fori I

**DIMENSIONS**  
width 56 cm  
depth 57 cm  
height 40 cm  
holes I

vaso a terra a filo parete  
floor-standing back-to-wall wc pan

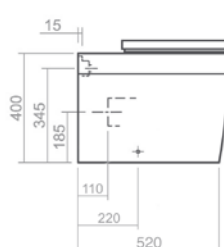
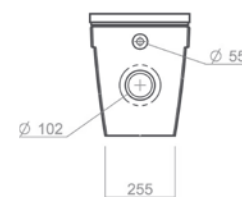
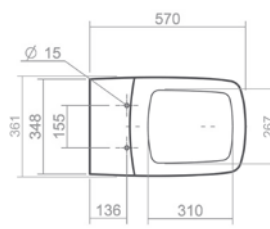

**DIMENSIONI**  
larghezza 36 cm  
profondità 57,3 cm  
altezza 40 cm

**DIMENSIONS**  
width 36 cm  
depth 57,3 cm  
height 40 cm

vaso a terra monoblocco con cassetta  
close coupled floor-standing wc pan  
with cistern

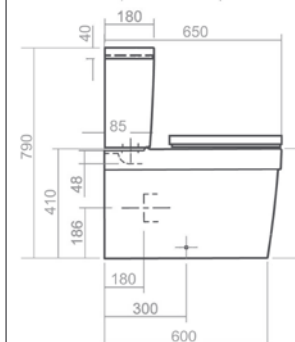
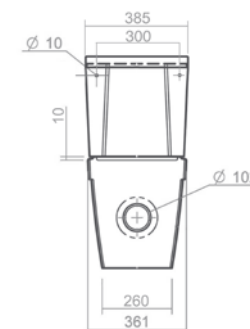
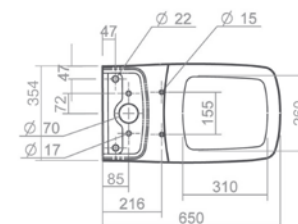

**DIMENSIONI**  
larghezza 38,5 cm  
profondità 65 cm  
altezza 79 cm con cassetta

**DIMENSIONS**  
width 38,5 cm  
depth 65 cm  
height 79 cm with cistern



# Jacuzzi® cognito



lavabo da 44 cm d'appoggio  
44 cm countertop basin

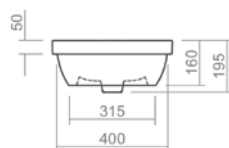
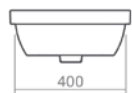
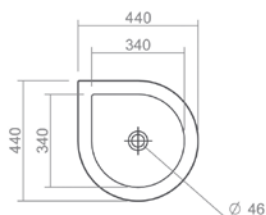

**DIMENSIONI**  
larghezza 44 cm  
profondità 44 cm  
altezza 16 cm

**DIMENSIONS**  
width 44 cm  
depth 44 cm  
height 16 cm



lavabo da 55 sospeso  
55 cm wall-mounted basin

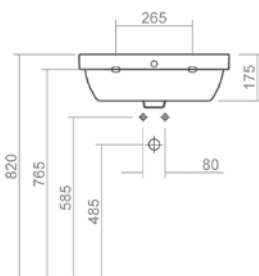
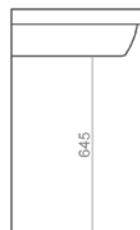
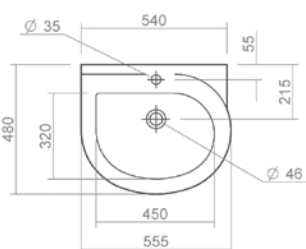

**DIMENSIONI**  
larghezza 55 cm  
profondità 48 cm  
altezza 17,5 cm  
fori I

**DIMENSIONS**  
width 55 cm  
depth 48 cm  
height 17,5 cm  
holes I



lavabo da 55 con semi colonna  
55 cm basin with semi-pedestal

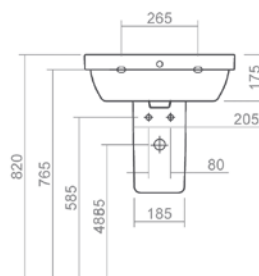
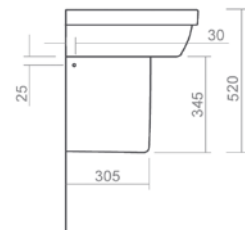
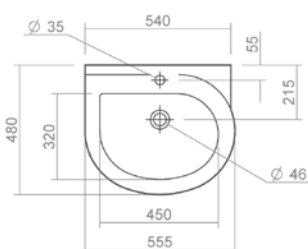

**DIMENSIONI**  
larghezza 55 cm  
profondità 48 cm  
altezza 52 cm  
fori I

**DIMENSIONS**  
width 55 cm  
depth 48 cm  
height 52 cm  
holes I



lavabo da 55 con colonna  
55 cm basin with pedestal

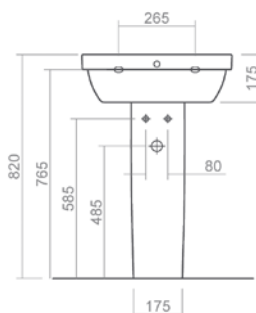
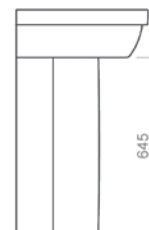
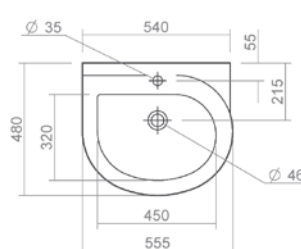

**DIMENSIONI**  
larghezza 55 cm  
profondità 48 cm  
altezza 82 cm  
fori I

**DIMENSIONS**  
width 55 cm  
depth 48 cm  
height 82 cm  
holes I



lavabo da 60 sospeso  
60 cm wall-mounted basin

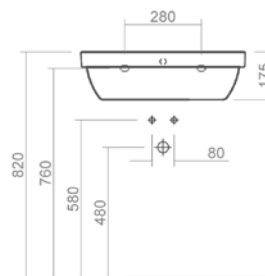
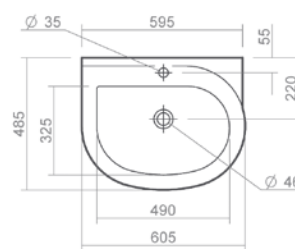

**DIMENSIONI**  
larghezza 60,5 cm  
profondità 48,5 cm  
altezza 17,5 cm  
fori I

**DIMENSIONS**  
width 60,5 cm  
depth 48,5 cm  
height 17,5 cm  
holes I



lavabo da 60 con semi colonna  
60 cm basin with semi-pedestal

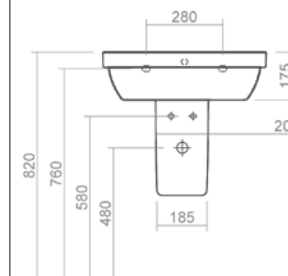
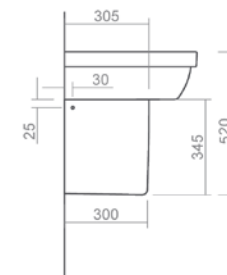
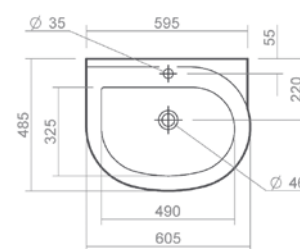

**DIMENSIONI**  
larghezza 60,5 cm  
profondità 48,5 cm  
altezza 52 cm  
fori I

**DIMENSIONS**  
width 60,5 cm  
depth 48,5 cm  
height 52 cm  
holes I



lavabo da 60 con colonna  
60 cm basin with pedestal

lavabo da 70 cm con colonna  
70 cm basin with pedestal

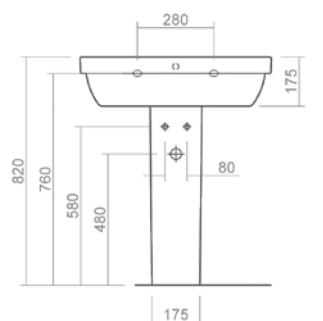
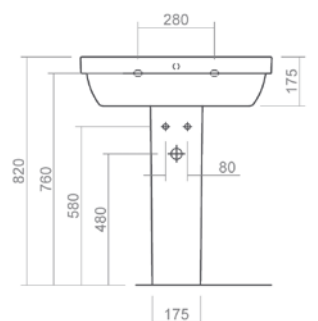
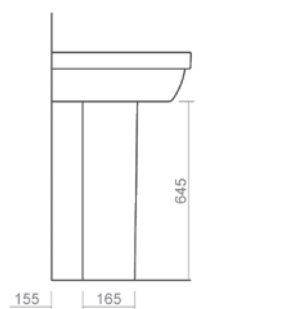
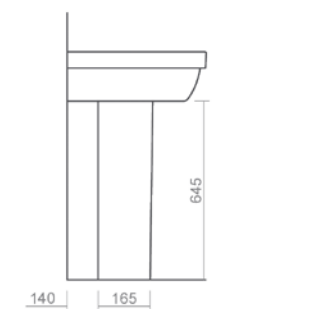
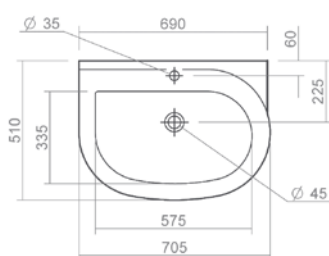
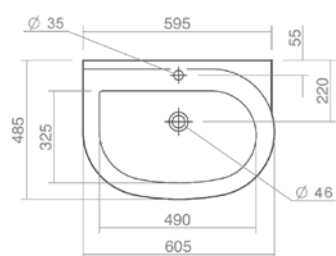

**DIMENSIONI**  
larghezza 60,5 cm  
profondità 48,5 cm  
altezza 82 cm  
fori 1

**DIMENSIONS**  
width 60,5 cm  
depth 48,5 cm  
height 82 cm  
holes 1

**DIMENSIONI**  
larghezza 70,5 cm  
profondità 51 cm  
altezza 82 cm  
fori 1

**DIMENSIONS**  
width 70,5 cm  
depth 51 cm  
height 82 cm  
holes 1



# Jacuzzi® cognito



**bidet sospeso**  
wall-mounted bidet

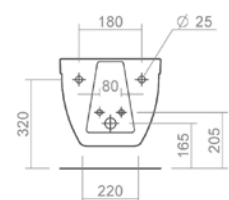
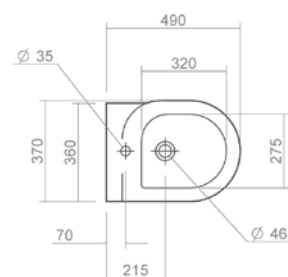

**DIMENSIONI**  
larghezza 37 cm  
profondità 50 cm  
altezza 40 cm da terra  
fori |

**DIMENSIONS**  
width 37 cm  
depth 50 cm  
height 40 cm above the floor  
holes |

**vaso sospeso**  
wall-mounted wc pan

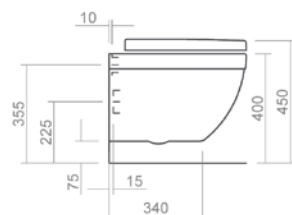
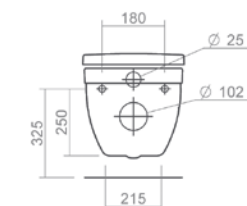
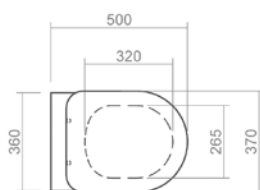

**DIMENSIONI**  
larghezza 37 cm  
profondità 50 cm  
altezza 40 cm da terra

**DIMENSIONS**  
width 37 cm  
depth 50 cm  
height 40 cm above the floor

**bidet a terra a filo parete**  
floor-standing back-to-wall bidet

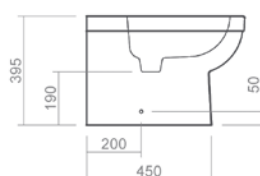
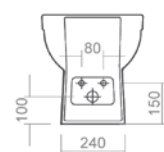
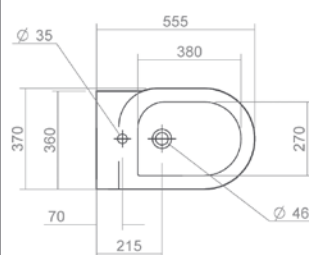

**DIMENSIONI**  
larghezza 37 cm  
profondità 55 cm  
altezza 39,5 cm  
fori |

**DIMENSIONS**  
width 37 cm  
depth 55 cm  
height 39,5 cm  
holes |

**vaso a terra a filo parete**  
floor-standing back-to-wall wc pan

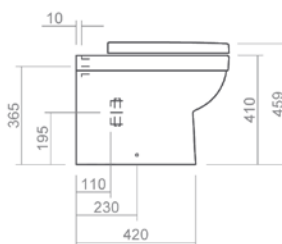
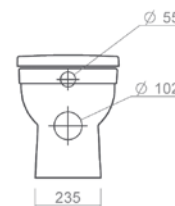
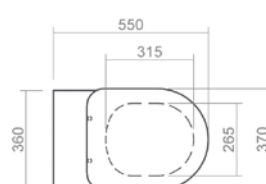

**DIMENSIONI**  
larghezza 37 cm  
profondità 55 cm  
altezza 41 cm

**DIMENSIONS**  
width 37 cm  
depth 55 cm  
height 41 cm

**vaso a terra monoblocco con cassetta**  
close coupled floor-standing wc pan  
with cistern

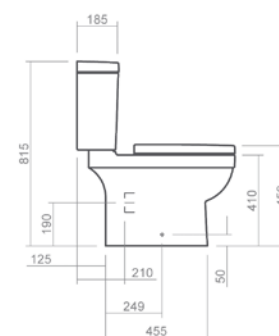
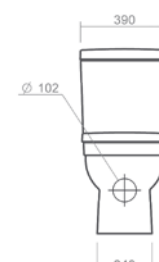
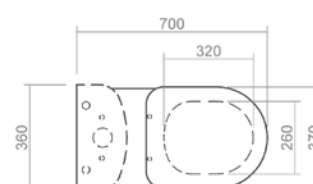

**DIMENSIONI**  
larghezza 39 cm  
profondità 70 cm  
altezza 81,5 cm con cassetta

**DIMENSIONS**  
width 39 cm  
depth 70 cm  
height 81,5 cm with cistern









## Jacuzzi® rubinetterie tapware

Ogni dettaglio della sala da bagno può essere firmato Jacuzzi®: nel mondo di un wellness globale legato all'universo dell'acqua, la ricerca estetica, l'eccellenza nella funzionalità, il design e lo studio dei materiali, coinvolgono il mondo della rubinetteria e offrono una sintesi ideale di perfezione e innovazione.

Interior design: le tendenze, gli stili, le abitudini, gli utilizzi. Tutto contribuisce, in un'ottica di ricerca della qualità totale, a creare la soluzione ideale per completare l'allestimento delle vasche e dei sanitari Jacuzzi®.

Oggetti da vivere: le rubinetterie Jacuzzi® sono belle da vedere, piacevoli da toccare, confortevoli da usare ogni giorno e possono essere installate su tutti i componenti del bagno dalle vasche, alle docce, ai sanitari. Per un ambiente completamente coordinato e firmato Jacuzzi®.

Every detail of the bathroom can be signed by Jacuzzi®: in a global wellness world connected to the universe of water, to research into aesthetics and to the excellence of functionality, the design and study of materials involve the world of tapware and offer an ideal blend of perfection and innovation.

Interior design: trends, styles, habits, uses. From the viewpoint of pursuing total quality, everything contributes to creating an ideal solution to complete the Jacuzzi® bath and sanitaryware fittings.

Objects to enjoy: the Jacuzzi® tapware is beautiful to look at, pleasant to touch, comfortable to use every day and can be installed on all bathroom components such as baths, showers and sanitaryware. For a fully coordinated environment signed by Jacuzzi®.



All'acqua si comanda: strumenti che personalizzano il bagno in modo prestigioso e danno una risposta immediata alla cura del corpo.  
Water can be controlled: tools that customise the bathroom in a prestigious way and give an immediate reply to body care requirements.









**Jacuzzi** morphosis

# Jacuzzi® morphosis

## Rubinetteria vasca

Bath tapware



Miscelatore bicomando. Bordo vasca 4 fori.  
Deviatore a due vie. Doccino a mano di serie.

Twin lever mixer. Deck mounted 4 holes.  
Two-way diverter switch. Standard handheld shower.

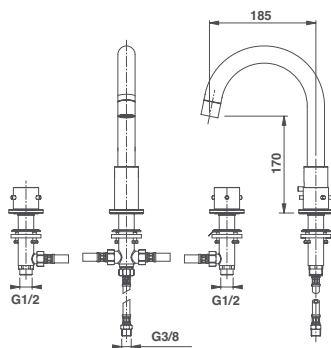

## Rubinetteria vasca

Bath tapware



Miscelatore monocomando a muro per vasca.  
Doccino a mano di serie.

Wall-mounted single lever bath mixer.  
Standard handheld shower.

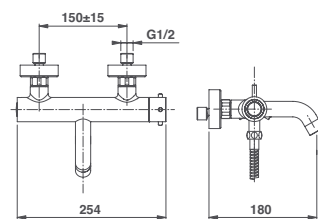

## Rubinetteria vasca

Bath tapware



Miscelatore monocomando da terra con doccino.

Floor-standing single lever mixer with handheld shower.

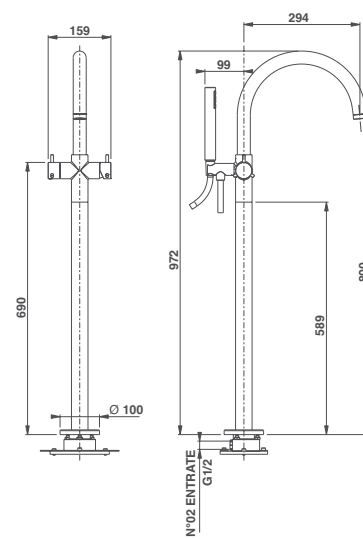

## Rubinetteria lavabo

Basin tapware



Miscelatore monocomando per lavabo.  
Da abbinare a clic-clac.

Single lever basin mixer.  
To be used with clic-clac waste.

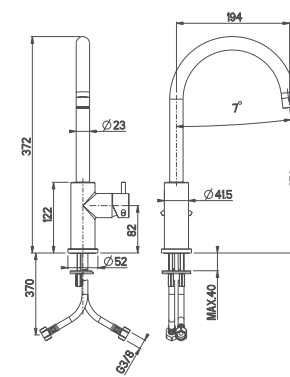



### Rubineria lavabo

Basin tapware



Miscelatore monocomando per lavabo.  
Da abbinare a clic-clac.

Single lever basin mixer.  
To be used with clic-clac waste.

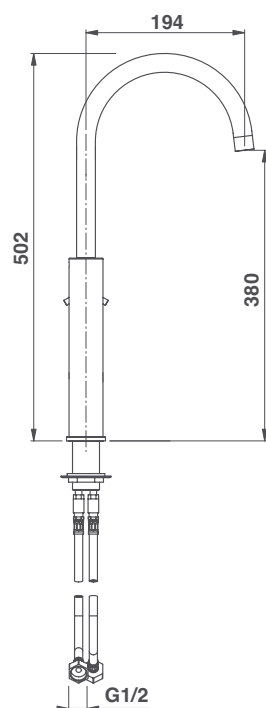

### Rubineria lavabo

Basin tapware



Miscelatore monocomando a muro per lavabo.  
Da abbinare a clic-clac.

Wall-mounted single lever basin mixer.  
To be used with clic-clac waste.

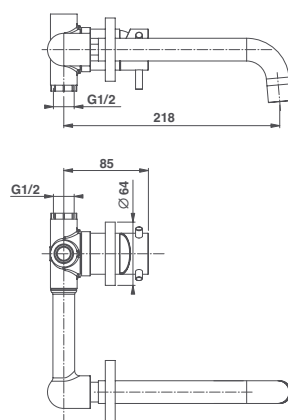

### Rubineria lavabo

Basin tapware



Miscelatore bicomando a muro per lavabo.  
Da abbinare a clic-clac.

Wall-mounted twin lever basin mixer.  
To be used with clic-clac waste.

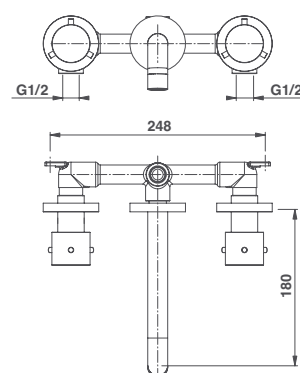

### Rubineria bidet

Bidet tapware



Miscelatore monocomando per bidet.  
Comando per saltarello.

Single lever bidet mixer.  
Pop up waste control.

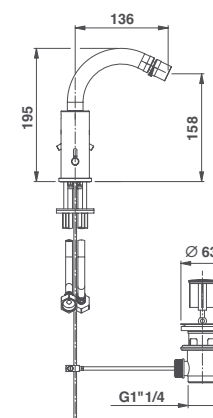

# Jacuzzi® morphosis

## Rubetteria box

Shower enclosure tapware



Miscelatore monocomando ad incasso per box doccia.  
Abbinabile a soffione a pioggia o doccino a mano.

Recessed single lever shower mixer.  
Can be used with raindrop showerhead or handheld shower.

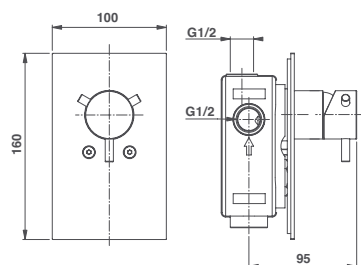

## Rubetteria box

Shower enclosure tapware



Miscelatore monocomando ad incasso per box doccia.  
Soffione a pioggia di serie.

Recessed single lever shower mixer.  
Standard showerhead.

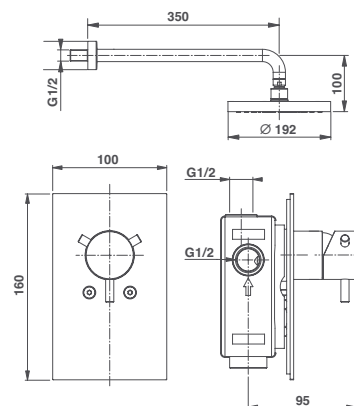

## Rubetteria box

Shower enclosure tapware



Miscelatore monocomando ad incasso per box doccia.  
Doccino a mano e asta saliscendi di serie.

Recessed single lever shower mixer.  
Standard handheld shower and riser rail.

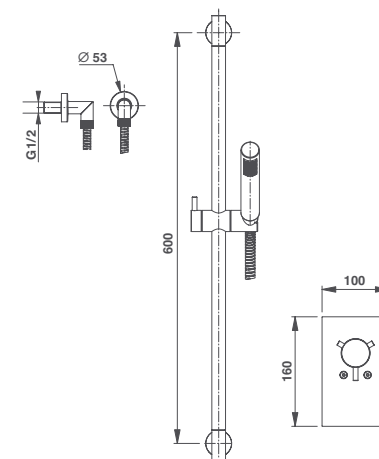

### Rubinetteria box

Shower enclosure tapware



Miscelatore monocomando ad incasso per box doccia o vasca.  
Deviatore a due vie.

Recessed single lever shower/bath mixer.  
Two-way diverter switch.

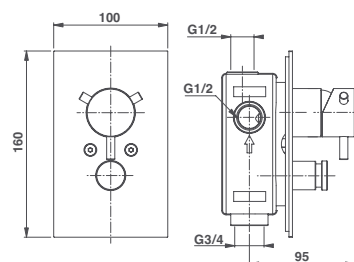

### Rubinetteria box

Shower enclosure tapware



Miscelatore monocomando ad incasso per box doccia o vasca.  
Deviatore a due vie. Soffione a pioggia, doccino a mano e asta saliscendi di serie.

Recessed single lever shower/bath mixer.  
Two-way diverter switch. Standard showerhead, handheld shower and riser rail.

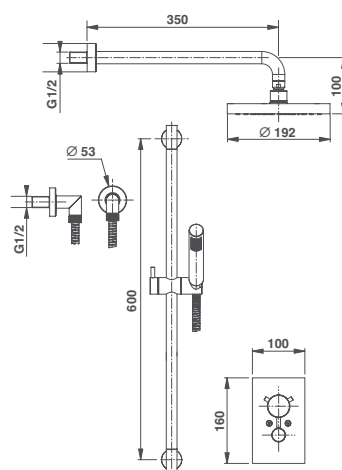

### Rubinetteria box

Shower enclosure tapware



Miscelatore monocomando esterno per box doccia.  
Doccino a mano e asta saliscendi di serie.

Single lever shower mixer.  
Standard handheld shower and riser rail.

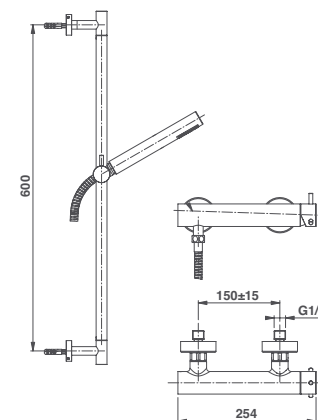

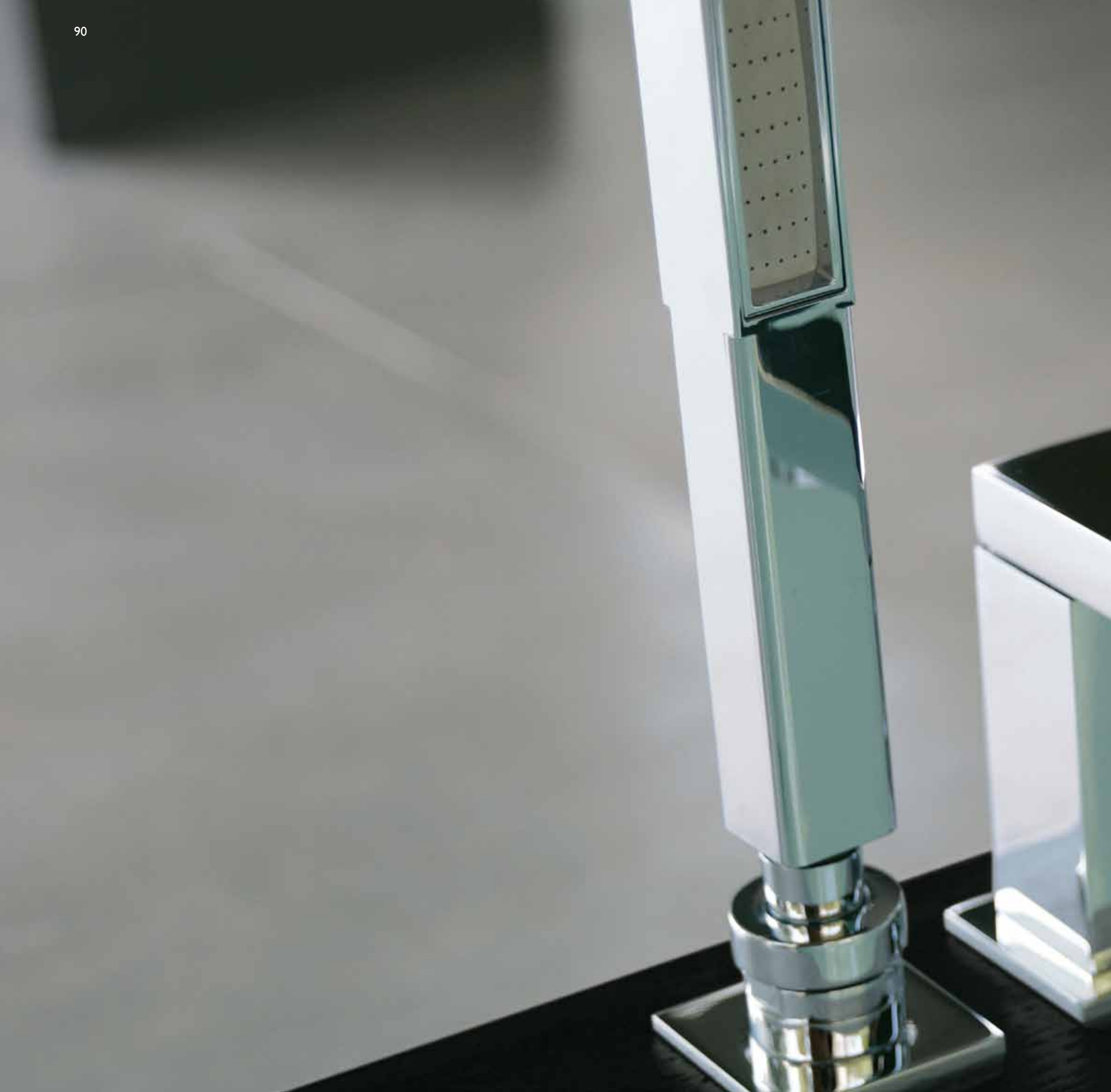



**Jacuzzi**® aura

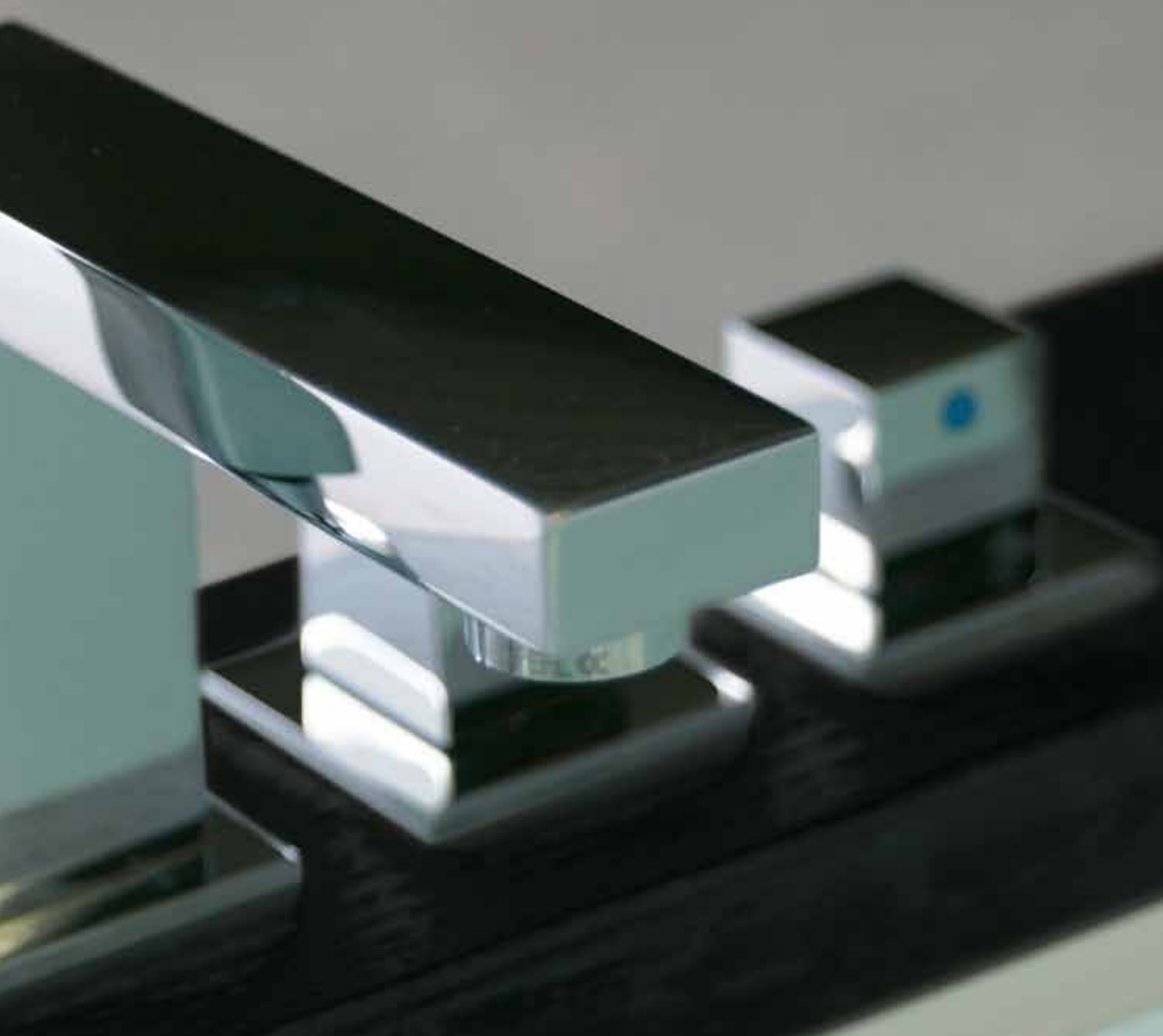

# Jacuzzi® aura

## Rubineria vasca

Bath tapware

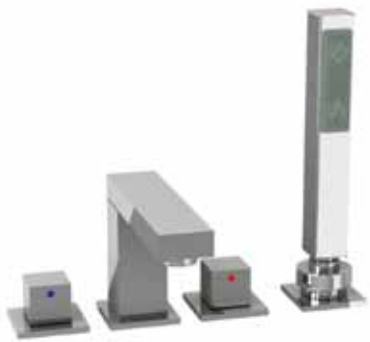

Miscelatore bicomando. Bordo vasca 4 fori.  
Deviatore a due vie. Doccino a mano di serie.

Twin lever mixer. Deck-mounted 4 holes.  
Two-way diverter switch. Standard handheld shower.

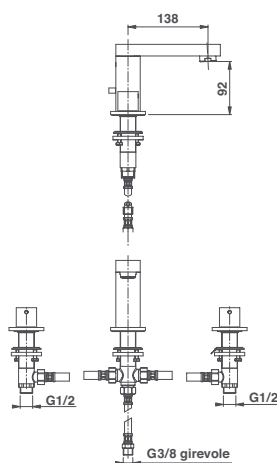

## Rubineria vasca

Bath tapware



Miscelatore bicomando. Bordo vasca 4 fori.  
Deviatore a due vie. Doccino a mano di serie.

Twin lever mixer. Deck-mounted 4 holes.  
Two-way diverter switch. Standard handheld shower.

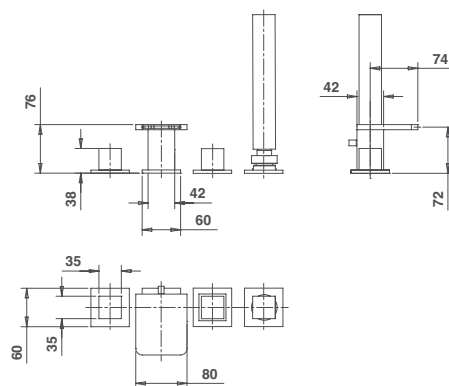

## Rubineria vasca

Bath tapware



Miscelatore monocomando a muro per vasca.  
Doccino a mano di serie.

Wall-mounted single lever bath mixer.  
Standard handheld shower.

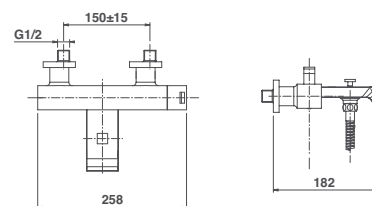

## Rubineria lavabo

Basin tapware



Miscelatore bicomando per lavabo a 3 fori.  
Da abbinare a clic-clac.

3 hole twin lever basin mixer.  
To be used with clic-clac waste.

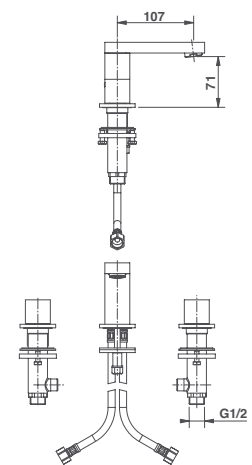

Da abbinare a click clack.  
To combine with click clack waste.

### Rubineria lavabo

Basin tapware



Miscelatore monocomando per lavabo.  
Comando per saltarello.

Single lever basin mixer.  
Pop-up waste control.

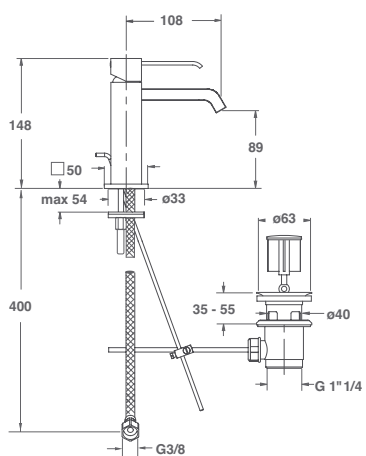

### Rubineria lavabo

Basin tapware



Miscelatore monocomando per lavabo.  
Da abbinare a clic-clac.

Single lever basin mixer.  
To be used with clic-clac waste.

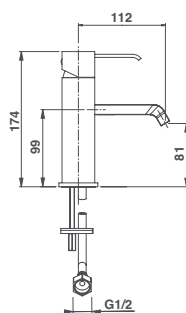

Da abbinare a click clack.  
To combine with click clack waste.

### Rubineria lavabo

Basin tapware

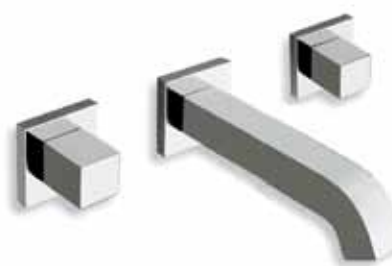

Miscelatore bicomando a muro per lavabo.  
Da abbinare a clic-clac.

Wall-mounted twin lever basin mixer.  
To be used with clic-clac waste.

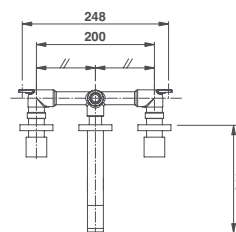

Da abbinare a click clack.  
To combine with click clack waste.

### Rubineria bidet

Bidet tapware



Miscelatore monocomando per bidet.  
Comando per saltarello.

Single lever bidet mixer.  
Pop-up waste control.

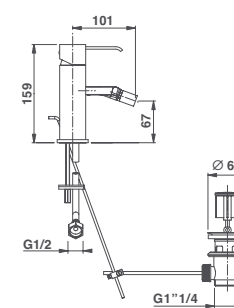

# Jacuzzi® aura

## Rubetteria box

Shower enclosure tapware



Miscelatore monocomando ad incasso per box doccia.  
Abbinabile a soffione a pioggia o doccino a mano.

Recessed single lever shower mixer.  
Can be used with raindrop showerhead or handheld shower.

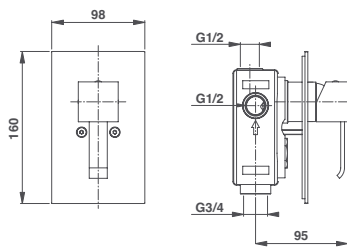

## Rubetteria box

Shower enclosure tapware



Miscelatore monocomando ad incasso per box doccia.  
Soffione a pioggia di serie.

Recessed single lever shower mixer.  
Standard shower head.

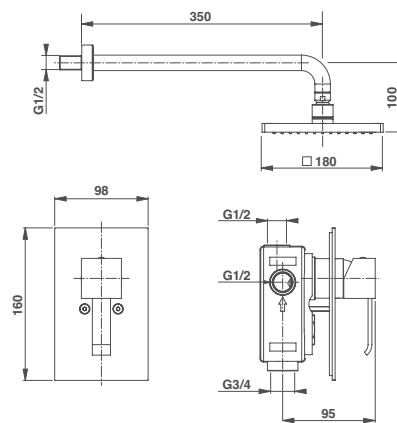

## Rubetteria box

Shower enclosure tapware



Miscelatore monocomando ad incasso per box doccia.  
Doccino a mano e asta saliscendi di serie.

Recessed single lever shower mixer.  
Standard handheld shower and riser rail.

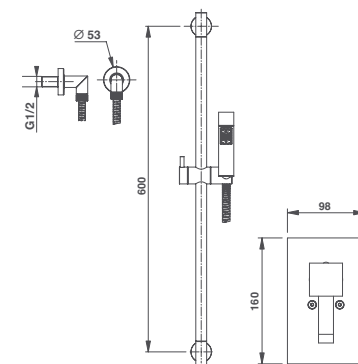

### Rubetteria box

Shower enclosure tapware



Miscelatore monocomando ad incasso per box doccia o vasca.  
Deviatore a due vie.

Recessed single lever shower/bath mixer.  
Two-way diverter switch.

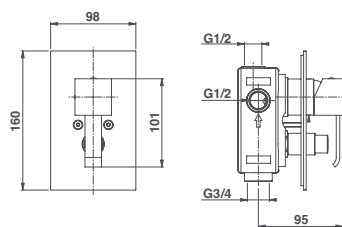

### Rubetteria box

Shower enclosure tapware



Miscelatore monocomando ad incasso per box doccia o vasca.  
Deviatore a due vie. Soffione a pioggia, doccino a mano e asta saliscendi di serie.

Recessed single lever shower/bath mixer.  
Two-way diverter switch. Standard showerhead, handheld shower and riser rail.

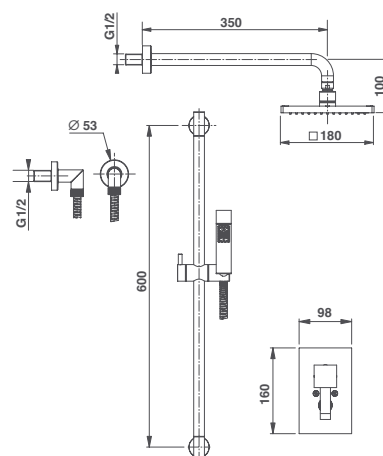

### Rubetteria box

Shower enclosure tapware



Miscelatore monocomando esterno per box doccia.  
Doccino a mano e asta saliscendi di serie.

Single lever shower mixer.  
Standard handheld shower and riser rail.

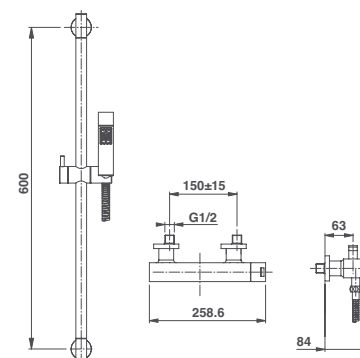





**Jacuzzi** young

# Jacuzzi® young

## Rubineria vasca

Bath tapware



Miscelatore bicomando. Bordo vasca 4 fori.  
Deviatore a due vie. Doccino a mano di serie.

Twin lever mixer. Deck-mounted 4 holes.  
Two-way diverter switch. Standard handheld shower.

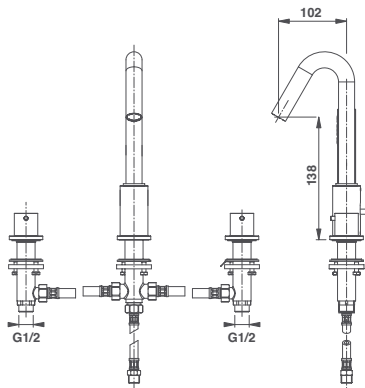

## Rubineria vasca

Bath tapware



Miscelatore monocomando a muro per vasca.  
Doccino a mano di serie.

Wall-mounted single lever bath mixer.  
Standard handheld shower.

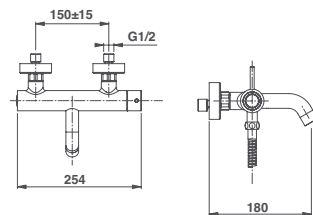

## Rubineria lavabo

Basin tapware



Miscelatore monocomando per lavabo.  
Da abbinare a clic-clac.

Single lever basin mixer.  
To be used with clic-clac waste.

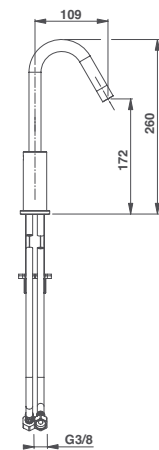

## Rubinetteria lavabo

Basin tapware



Miscelatore monocomando a muro per lavabo.  
Da abbinare a clic-clac.

Wall-mounted single lever basin mixer.  
To be used with clic-clac waste.

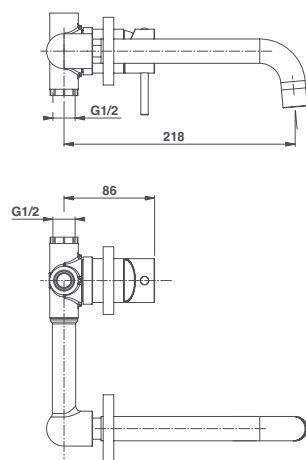

## Rubinetteria bidet

Bidet tapware



Miscelatore monocomando per bidet.  
Da abbinare a clic-clac.

Single lever bidet mixer.  
To be used with clic-clac waste.

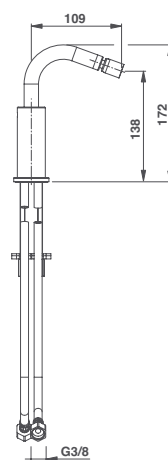

# Jacuzzi® young

## Rubinetteria box

Shower enclosure tapware



Miscelatore monocomando ad incasso per box doccia.  
Abbinabile a soffione a pioggia o doccino a mano.

Recessed single lever shower mixer.  
Can be used with raindrop showerhead or handheld shower.

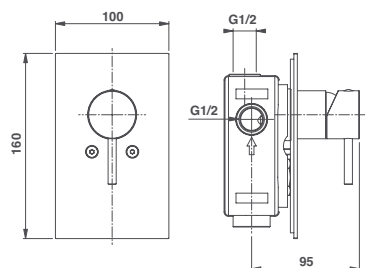

## Rubinetteria box

Shower enclosure tapware



Miscelatore monocomando ad incasso per box doccia.  
Soffione a pioggia di serie.

Recessed single lever shower mixer.  
Standard showerhead.

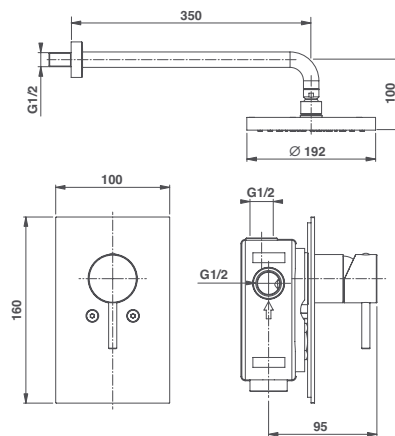

## Rubinetteria box

Shower enclosure tapware



Miscelatore monocomando ad incasso per box doccia.  
Doccino a mano e asta saliscendi di serie.

Recessed single lever shower mixer.  
Standard handheld shower and riser rail.

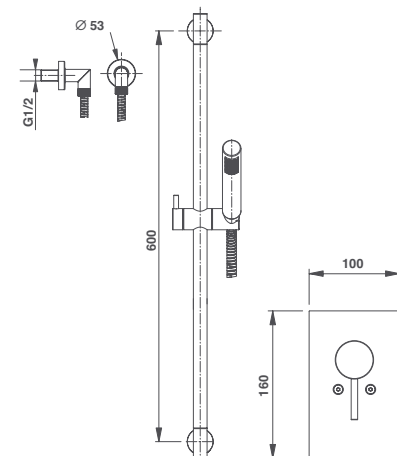



### Rubinetteria box

Shower enclosure tapware



Miscelatore monocomando ad incasso per box doccia o vasca.  
Deviatore a due vie.

Recessed single lever shower/bath mixer.  
Two-way diverter switch.

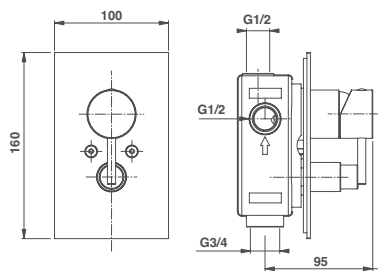

### Rubinetteria box

Shower enclosure tapware



Miscelatore monocomando ad incasso per box doccia o vasca.  
Deviatore a due vie. Soffione a pioggia, doccino a mano e asta saliscendi di serie.

Recessed single lever shower/bath mixer.  
Two-way diverter switch. Standard showerhead, handheld shower and riser rail.

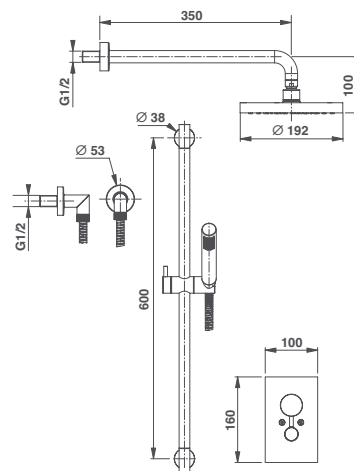

### Rubinetteria box

Shower enclosure tapware



Miscelatore monocomando esterno per box doccia.  
Doccino a mano e asta saliscendi di serie.

Single lever shower mixer.  
Standard handheld shower and riser rail.

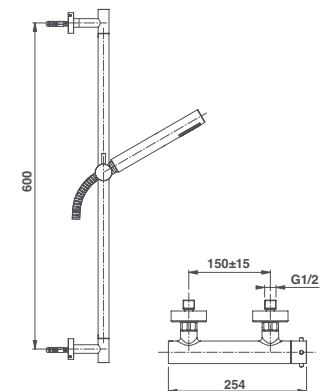





## wellness firmato e certificato **Jacuzzi®**

wellness, signed and sealed by Jacuzzi®.

Abbiamo del wellness un concetto molto esteso, nel tempo e nello spazio. Per noi il benessere non è mai un concetto astratto, significa, ad esempio, che i nostri prodotti fanno star bene anche perché sono sicuri e funzionano perfettamente.

Per ottenere questo, siamo rivolti al benessere in ogni momento, in ogni dettaglio: effettuiamo controlli più severi degli standard di sicurezza internazionali, tutti i nostri modelli sono collaudati uno ad uno e corredati da un certificato firmato. Ulteriori prove di sicurezza vengono eseguite a cura di Istituti di controllo esterni riconosciuti a livello mondiale: Jacuzzi Europe S.p.A. è certificata UNI EN ISO 9001:2008.

Questo, per Jacuzzi, significa benessere davvero totale.

Our idea of wellness is a broad one in every sense. For us, wellness is never an abstract concept: it means that our products make you feel good because they are safe, and function perfectly.

To achieve this result, we consider the concept of wellness from every angle, in every detail, by conducting tests that satisfy the most stringent international safety regulations on all of our products, tested one by one and supplied with a signed certificate. Additional safety checks are performed by internationally-recognised independent testing institutions. Jacuzzi Europe S.p.A. is certified according to UNI EN ISO 9001:2008 standards.

For Jacuzzi this is what total wellness means.

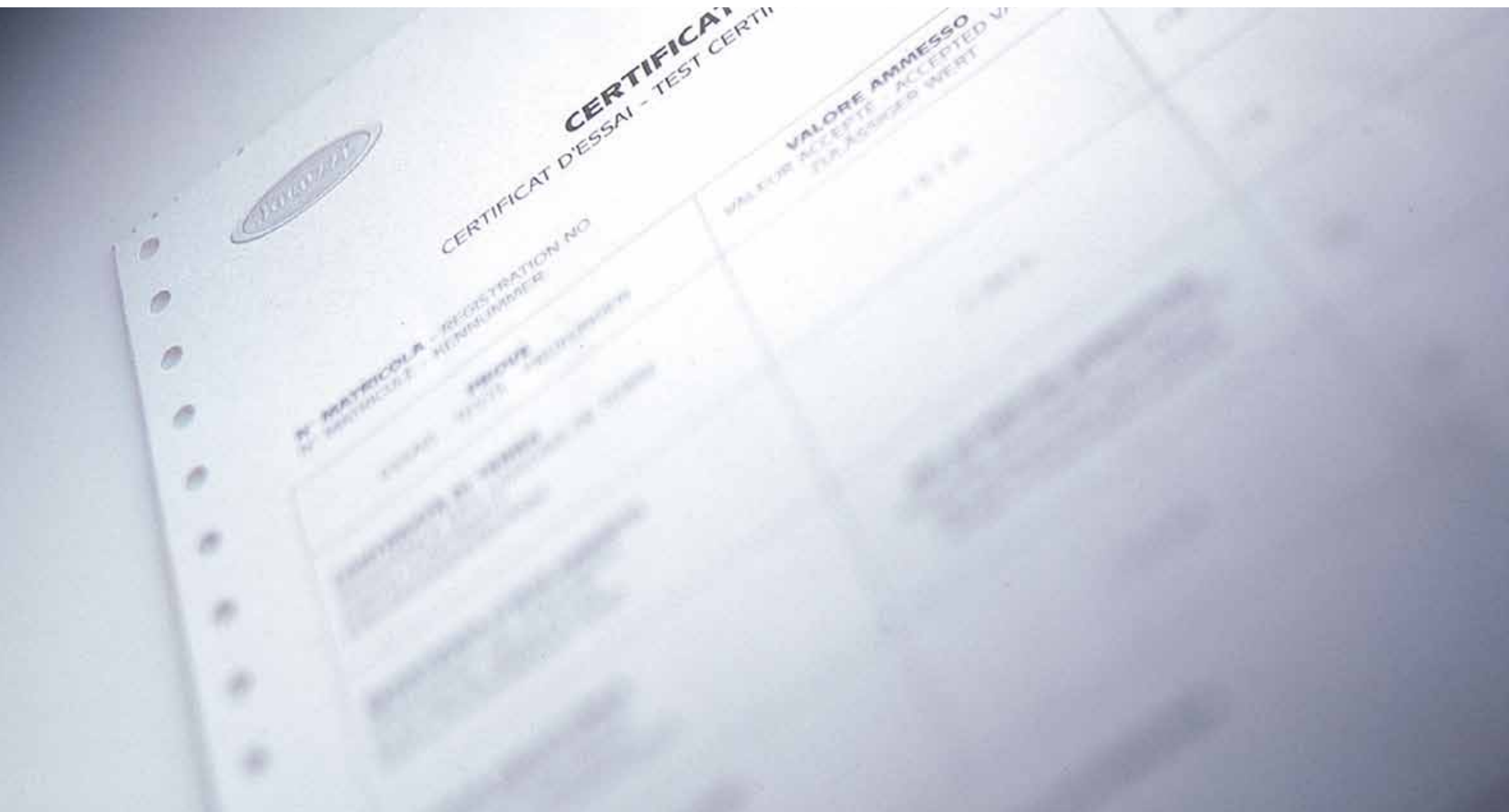

## Jacuzzi® j-service essere jacuzzi® anche nel servizio

Jacuzzi® J-Service: quality even for our after sales service

Il benessere secondo Jacuzzi® vuol dire anche non avere pensieri: sapere di avere alle spalle in ogni momento J-Service, un'organizzazione composta da professionisti qualificati per garantire la perfetta efficienza dei prodotti Jacuzzi® nel tempo. Significa avere Jacuzzi® al proprio servizio. Se non è benessere questo?

J-Service.

I Centri Assistenza Jacuzzi® offrono un servizio di supporto post-vendita capillare e tempestivo: dalla consulenza ai clienti, alla manutenzione periodica dei prodotti, all'affiancamento tecnico per l'installazione.

Per quest'ultima, J-Service ha previsto due formule:

- montaggio congiunto – un tecnico J-Service affianca l'installatore nel montaggio e messa in opera del prodotto, fornendogli un'assistenza qualificata (questo servizio è valido solo in Italia).
- installazione completa – l'installatore può affidare ai tecnici J-Service il montaggio totale e l'installazione completa del prodotto.

Garanzia.

Alla rete J-service è affidata la gestione della Garanzia Totale di 24 mesi, senza alcun onere a carico del cliente. I Centri assistenza utilizzano esclusivamente ricambi originali Jacuzzi® e si fanno garanti di eventuali non conformità riconducibili all'installazione del prodotto. La Garanzia può essere estesa fino a 5 anni, aderendo al programma di manutenzione periodica (estensione ottenibile solo in Italia).

The Jacuzzi® concept of wellness also means freedom from worry, knowing that you can always count on J-Service, an organisation whose qualified team of professionals will guarantee a fully-functioning Jacuzzi® product at all times. It means having Jacuzzi® at your service. If that's not wellness, what is?

J-Service.

The extensive network of Jacuzzi® service centres offers a prompt after-sales service that includes customer advice, periodic maintenance and technical support when it comes to installation.

Two installation packages are available:

- Joint installation – a J-Service technician will help your installer with fitting and start-up, providing expert advice (this service is only available in Italy).
- Full installation – your contractor can leave all the assembly and installation to our expert J-Service technicians.

Warranty.

The J-Service network is responsible for the Full 24-month Warranty, at no cost to the customer. Our service centres only use original Jacuzzi® parts, and will answer for any non-conformities related to product installation. Membership of the periodic maintenance programme gives you the option to extend the warranty up to 5 years (warranty extension is only available in Italy).





JACUZZI EUROPE S.p.A.

Socio Unico  
Direzione e Coordinamento  
Jacuzzi Brands, Corp. (USA)  
S.S. Pontebbana Km 97,200  
33098 Valvasone (PN) Italia  
Tel. +39-0434-859111  
Fax +39-0434-85278  
www.jacuzzi.eu  
e-mail: info@jacuzzi.it

JACUZZI BATHROOM ESPAÑA S.L.

Sociedad unipersonal  
A Company of  
Jacuzzi Brands, Corp. (USA)  
Ausias Marc, 157-159  
Graner, local A  
08013 Barcelona, España  
Telf. 932385031 - 932384162  
Fax 932385032 - 932722149  
www.jacuzzi.eu  
e-mail: info-es@jacuzzi.it

JACUZZI WHIRLPOOL GmbH

Humboldtstr. 30/32  
D-70771 Leinfelden-Echterdingen  
Deutschland  
Tel. 0049 (0)711 933247-40  
Fax 0049 (0)711 933247-50  
www.jacuzzi.eu  
e-mail: info-de@jacuzzi.it



Per le predisposizioni di installazione fare riferimento esclusivamente alle schede di pre-installazione.  
For installation please exclusively refer to the pre-installation manuals only.

I dati e le caratteristiche indicate non impegnano la Jacuzzi Europe Spa, che si riserva il diritto di apportare delle modifiche ritenute opportune senza obbligo di preavviso o di sostituzione.  
The data and information given here are not binding for Jacuzzi Europe Spa, which reserves the right to make any modifications necessary without prior notice or replacements.

Concept and graphic project: The Ad Store Italia



